



Ecodesign preparatory study on mobile phones, smartphones and tablets

Final Task 4 Report
Technologies



Authors:

Karsten Schischke (Fraunhofer IZM)
Christian Clemm (Fraunhofer IZM)
Anton Berwald (Fraunhofer IZM)
Marina Proske (Fraunhofer IZM)
Gergana Dimitrova (Fraunhofer IZM)
Julia Reinhold (Fraunhofer IZM)
Carolin Prewitz (Fraunhofer IZM)
Christoph Neef (Fraunhofer ISI)

Contributors:

Antoine Durand (Quality control, Fraunhofer ISI)
Clemens Rohde (Quality control, Fraunhofer ISI)
Simon Hirzel (Quality control, Fraunhofer ISI)
Mihaela Thuring (Quality control, contract management, VITO)

Study website: <https://www.ecosmartphones.info>

EUROPEAN COMMISSION

Directorate-General for Internal Market, Industry, Entrepreneurship and SMEs
Directorate C – Sustainable Industry and Mobility
DDG1.C.1 – Circular Economy and Construction

Contact: Davide Polverini

E-mail: davide.polverini@ec.europa.eu

European Commission
B-1049 Brussels

Ecodesign preparatory study on mobile phones, smartphones and tablets

Final Task 4 Report

Technologies

***Europe Direct is a service to help you find answers
to your questions about the European Union.***

Freephone number (*):

00 800 6 7 8 9 10 11

(*) The information given is free, as are most calls (though some operators, phone boxes or hotels may charge you).

LEGAL NOTICE

This document has been prepared for the European Commission however it reflects the views only of the authors, and the Commission cannot be held responsible for any use which may be made of the information contained therein.

More information on the European Union is available on the Internet (<http://www.europa.eu>).

Luxembourg: Publications Office of the European Union, 2021

© European Union, 2021

Reproduction is authorised provided the source is acknowledged.

Printed in Belgium

CONTENT

1.	GLOSSARY.....	13
2.	INTRODUCTION	17
3.	SUBTASK 4.1 – TECHNICAL PRODUCT DESCRIPTION	17
3.1.	Average Technology: Products	17
3.1.1.	Mobile phones	17
3.1.2.	Tablets	44
3.1.3.	Cordless phones	57
3.2.	Average Technology: Components	65
3.2.1.	Frame and back cover.....	65
3.2.2.	Display assembly.....	65
3.2.3.	Batteries	67
3.2.4.	Semiconductors	74
3.2.5.	Camera.....	80
3.2.6.	Connections	81
3.2.7.	Other functional parts	81
3.2.8.	Software.....	82
3.2.9.	Chargers.....	85
3.2.10.	Accessories	85
3.3.	BAT – Best Available Technology at product level	86
3.3.1.	Mobile phones	86
3.3.2.	Tablet.....	94
3.3.3.	Cordless phones.....	100
3.4.	BAT – Best Available Technology at component level.....	100
3.4.1.	Battery	101
3.4.2.	Cover and backside glass.....	101
3.4.3.	Parts with recycled or bio-based materials	102
3.4.4.	Semiconductors	102
3.5.	BNAT – Best Not Available Technology	102
3.5.1.	Housing with 100% recycled plastics.....	102
3.5.2.	Universal compatibility	102
3.5.3.	Product modularity	103
3.5.4.	Modular RAM and modular SSD.....	103
3.5.5.	Display cover glass	103
3.5.6.	Solid state batteries (SSB)	103
3.5.7.	Technology Outlook.....	104
4.	SUBTASK 4.2 – PRODUCTION, DISTRIBUTION AND END-OF-LIFE.....	109
4.1.	Product weight and Bills-of-Materials (BOMs).....	110

4.2.	Assessment of the primary scrap production during sheet metal manufacturing.....	110
4.3.	Packaging materials.....	111
4.4.	Volume and weight of the packaged product.....	111
4.5.	Actual means of transport employed in shipment of components, sub-assemblies and finished products.....	112
4.6.	Technical product life	112
4.7.	Materials flow and collection effort at end-of-life	113
5.	PUBLICATION BIBLIOGRAPHY	113
6.	ANNEX	121
6.1.	Tested DECT phones	121

FIGURES

Figure 1: Teardown of a smartphone (Samsung Galaxy S5)	18
Figure 2: Development of the amount of RAM and internal storage employed in smartphones between 2010 and 2019 (Clemm et al. 2020)	21
Figure 3: Development of the amount of RAM and internal storage employed in mobile phones between 2000 and 2020 per price category (Proske et al. 2020a)	21
Figure 4: Development of internal storage employed in smartphones, 2017-2020, market share (data provided by an anonymous OEM)	22
Figure 5: Development of the display size and screen-to-body ration in smartphones between 2010 and 2019 (Clemm et al. 2020)	22
Figure 6: Development of the display size and screen-to-body ration in mobile phones between 2005 and 2020 per price segment (Proske et al. 2020a)	23
Figure 7: Development of weight and weight per display size in mobile phones between 2000 and 2020 per price segment (Proske et al. 2020a)	23
Figure 8: Smartphone display designs – market share, 2019, Europe.....	24
Figure 9: display type and resolution of mobile phones between 2000 and 2020 (Proske et al. 2020a)	24
Figure 10: Mobile network generation technology in mobile phones between 2000 and 2020 (Proske et al. 2020a)	25
Figure 11: Smartphones - 5G market penetration forecast (data provided by an anonymous OEM)	25
Figure 12: Evolution of smartphone case joining techniques applied to the best-selling smartphones in Europe (based on market data from Counterpoint Research; market coverage denoted on top of data columns).	26
Figure 13: Trend towards the use of adhesives to fix the battery within smartphones among the best-selling smartphones in Europe (based on market data from Counterpoint Research; market coverage denoted on top of data columns)	26
Figure 14: Development of the battery capacity in smartphones between 2010 and 2019 (Clemm et al. 2020)	27
Figure 15: Development of the battery capacity in mobile phones between 2000 and 2020 per price segment (Proske et al. 2020a).....	27
Figure 16: share of user-replaceable and not user-replaceable batteries in mobile phones between 2000 and 2020 (Proske et al. 2020a)	28
Figure 17 : Coevolution of the smartphone design trends embedded battery, glass back cover, IP rating and wireless charging (Clemm et al. 2020)	28
Figure 18: Development of backside and frame material in mobile phones between 2010 and 2020 (Proske et al. 2020a)	29
Figure 19 : Tantalum capacitor, top-view and cross-section, tantalum containing parts highlighted	31
Figure 20 : Disassembled vibration motor of a 2012 smartphone model, tungsten part marked in red.....	32
Figure 21: WLAN module with GaAs and Silicon chips in one package (Quad Flat No-Lead package; top-view X-ray, left, and schematic drawing, right)	32
Figure 22 : Material content of selected metals in conventional mobile phones and smartphones (data source: Bookhagen et al.)	33

Figure 23 : Feature phones – major parts, materials and weights	37
Figure 24 : Smartphones – Power consumption in various modes (Notebookcheck 2020)	38
Figure 25 : Smartphones – Battery endurance testing results (GSMarena 2020)	39
Figure 26 : Smartphones – Battery endurance correlated with battery capacity (GSMarena 2020)	39
Figure 27 : Smartphones – Normalised battery endurance correlated with display size (GSMarena 2020)	40
Figure 28 : Smartphones – Normalised battery endurance testing results (GSMarena 2020)	40
Figure 29 : Mobile phones – end of life routes in Belgium (van der Voort 2013)	43
Figure 30: End of life of chargers (Ipsos, Trinomics, Fraunhofer FOKUS, Economisti Associati 2019)	44
Figure 31 : Tablet computers, battery capacity and number of models (2020)	45
Figure 32: Development of the amount of RAM and internal storage employed in tablets between 2008 and 2020	46
Figure 33: Development of screen size and screen-to-body ratio of tablets between 2008 and 2020	46
Figure 34: Development of battery capacity of tablets between 2008 and 2020	47
Figure 35: display type and resolution of tablets between 2008 and 2020	47
Figure 36: user-replaceability of batteries in tablets between 2008 and 2020	47
Figure 37: backside and frame material of tablets between 2013 and 2020	48
Figure 38: Mobile network generation technology in tablets between 2008 and 2020	48
Figure 39: Radio-frequency part of tablet mainboard, Ga marked as found by μ RFA	49
Figure 40 : Tablet computers, weight correlated with display sizes (2020)	51
Figure 41 : Tablet computers, material composition, Huawei (2016-2018)	51
Figure 42: weight of tablets between 2008 and 2020	52
Figure 43 : Tablets – Power consumption in various modes (Notebookcheck 2020)	55
Figure 44 : Features DECT phones (data by Stiftung Warentest, compilation by Fraunhofer IZM)	58
Figure 45 : Weight, DECT phones (data by Stiftung Warentest, compilation by Fraunhofer IZM)	58
Figure 46 : Cordless phone handset teardown – frontside, batteries, battery cover	60
Figure 47 : Cordless phone handset teardown – frontside cover, key pad, display and mainboard, backside cover	60
Figure 48 : Cordless phone handset teardown – frontside cover inside view, key pad backside, mainboard reverse side, display unit backside view, loudspeaker, backside cover	61
Figure 49 : Cordless phone handset teardown – mainboard	61
Figure 50 : Cordless phone base station teardown – overview	62
Figure 51 : Cordless phone base station teardown – cover (right) removed	62
Figure 52 : Cordless phone base station teardown – printed circuit board, key pad, loudspeaker	63
Figure 53 : Cordless phone base station teardown – printed circuit board downside	63

Figure 54 : Standby power consumption, DECT phones / charging cradle / base station (data by Stiftung Warentest, compilation by Fraunhofer IZM)	64
Figure 55 : Phone call times with fully charged batteries and charging times, DECT phones (data by Stiftung Warentest, compilation by Fraunhofer IZM)	64
Figure 56 : Standby duration in standard and eco mode, DECT phones (data by Stiftung Warentest, compilation by Fraunhofer IZM)	65
Figure 57 : Demonstration of a still functioning digitizer unit of a tablet lifted off from the LCD unit.....	66
Figure 58 : Development of LIB markets for cellular phones and tablets. Data taken from (Pillot 2017; B3 Corp.; B3 Corp.)	70
Figure 59 : State of health (SOH) of smartphone batteries, clustered into intervals of battery age in years, over the course of 1.000 charging cycles (Clemm et al. 2016b).	72
Figure 60 : State of health (SOH) of tablet batteries, clustered into intervals of battery age in years, over the course of 500 charging cycles. The statistics below present the share of data points in each interval that have retained at least 80 % and 60 % SOH (Clemm et al. 2016b).	73
Figure 61: Tablet battery capacity deterioration over load cycles (Source: Fraunhofer IZM)	73
Figure 62 : Cross-section of a tablet processor (A6X) mounted on the mainboard	77
Figure 63 : DRAM memory density in Gb per mm ² chip area	79
Figure 64 : Flash memory density in Gb per mm ² chip area	80
Figure 65 : Accessories in a smartphone packaging	86
Figure 66 : Samsung Galaxy S5, backside cover removed	90
Figure 67 : Battery with pull-tab adhesive strips.....	90
Figure 68 : Amount of connectors on logic boards of iPhones, 2007-2018 (Schischke et al. 2019)	92
Figure 69 : Compliance of EPEAT-registered mobile phones with optional criteria (active products as of June 17, 2020)	94
Figure 70 : Wooden parts of the D4R iameco tablet, Kappa prototype (Maher et al. 2018)	96
Figure 71 : Compliance of EPEAT-registered Tablets / Slates with optional criteria (active products as of June 17, 2020)	99

TABLES

Table 1 : Smartphone's functions and related characteristics (Cordella et al. 2020) ..	18
Table 2 : Smartphone market segments (typical specifications).....	20
Table 3 : (Selected) material content smartphone, feature phone	34
Table 4 : Energy consumption for smartphones (Kemna et al. 2020).....	41
Table 5 : Use phase power consumption of exemplary mobile phones (Apple 2020a; Google 2020b).....	42
Table 6 : ICT Electricity Consumption, EU27 (Kemna et al. 2020)	42
Table 7 : Collection rates (Sander et al. 2019)	43
Table 8: Tablet computer average configuration	45
Table 9: Tablets, composition (2013)	49
Table 10 : Material content tablets.....	50
Table 11 : Material composition Google Pixel Slate.....	52
Table 12 : Average power consumption data for Slate/Tablet computers, 2017 data .	53
Table 13 : Use phase power consumption of exemplary tablets	54
Table 14 : Energy efficiency metric for tablets (Kemna et al. 2020)	55
Table 15 : Tablets, EoL scenarios (Arduin et al. 2017).....	57
Table 16 : Material content landline phones	59
Table 17 : Integrated Circuits in an exemplary smartphone, compilation based on (Electronicproducts 2016)	75
Table 18 : Aggregated semiconductor parameters for an exemplary smartphone.....	76
Table 19 : Selected mobile phone and tablet processors	78
Table 20 : USB Generations and Terminologies (Sosnowsky 2020)	81
Table 21 : Availability of Operating System security updates, adapted from (Mobile & SecurityLab 2019).....	83
Table 22 : Comparison of charger specifications for tablets and smartphones.....	85
Table 23 : Recycled material in smartphones (Apple Inc. 2020; Google 2020a; Samsung 2020; Fairphone 2020; Umicore 2020; Fairphone 2018; Apple 2020b)	88
Table 24 : Biobased material in smartphones (Apple Inc. 2020; Google 2020a; Samsung 2020; Fairphone 2020; Umicore 2020; Fairphone 2018)	88
Table 25 : Reparability assessment of best scoring smartphones by iFixit	91

Table 26 : Recycled material in tablets (Apple Inc. 2020; Google 2020a; Samsung 2020; Fairphone 2020; Umicore 2020; Fairphone 2018)	95
Table 27 : Reparability assessment of best scoring tablets by iFixit.....	97
Table 28 : DECT phone BAT values	100
Table 29 : Specification of Corning Glass generations 5, 6, and 7 (Corning 2020b, 2020a, 2020c)	101
Table 30 : Selection of recent Patents on Mobile Devices with particular Relevancy for Ecodesign	104
Table 31 : Bill of Materials structure for base cases and approximate product weights (excluding accessories and packaging)	110
Table 32 : Base Cases – Packaging materials weights	111
Table 33 : Package dimension of exemplary smartphones (analysis by Fraunhofer IZM)	111
Table 34 : Base Cases - Package dimensions	112
Table 35 : Base Cases – Active use lifetime	112

1. GLOSSARY

Term	Definition
2G	2nd Generation
3D	Three-dimensional
3G	3rd Generation
3TG	Tin, Tantalum, Tungsten and Gold
4G	4th Generation
5G	5th Generation
ABS	Acrylonitrile Butadiene Styrene
AI	Artificial Intelligence
AMOLED	Active Matrix Organic Light Emitting Diode
ATL	Amperex Technology
BAT	Best Available Technologies
BEIDOU	BeiDou Navigation Satellite System (BDS)
BGA	Ball Grid Array
BMS	Battery Management Systems
BNAT	Best Not yet Available Technologies
BOM	Bill-of-Materials
BSI	Back side Illumination
BT	Bluetooth
CDMA	Code Division Multiple Access
CIS	CMOS Image Sensor
CMOS	Complementary Metal Oxide Semiconductor
CNC	Computerized Numerical Control
CO2	Carbon Dioxide
COG	Chip On Glass
CPU	Central Processing Unit
CS	Corporate Sustainability
DECT	Digital Enhanced Cordless Telecommunications
DFN	Dual Flat No-lead
DG GROW	Directorate-General for Internal Market, Industry, Entrepreneurship and SMEs
DOD	Depth of Discharge
DRAM	Dynamic Random Access Memory
Eco DECT	Economic Digital Enhanced Cordless Telecommunications
EDGE	Enhanced Data Rates
EEE	Electrical and Electronic Equipment
EEPROM	Electrically Erasable Programmable Read-Only Memory
EMI	Electromagnetic Interference
EN	European Norm
EoL	End of Life
EPEAT	Electronic Product Environmental Assessment Tool
EPS	Expanded Polystyrene
eSIM	embedded SIM
EU	European Union
EVDO	Evolution-Data Optimized

FHE	Flexible Hybrid Electronics
FM	Frequency Modulation
GaAs	Gallium Arsenide
GB	Gigabyte
GF	Glass Fibre
GLONASS	Global Navigation Satellite System
GSM	Global System for Mobile Communications
GPS	Global Positioning System
GPU	Graphics Processing Unit
HD	High Definition
HSPA	High Speed Packet Access
Hz	Hertz
IC	Integrated Circuit
ICT	Information and Communications Technology
ID	Identification
IEEE	Institute of Electrical and Electronic Engineers
iNemi	International Electronics Manufacturing Initiative
IP	Internet Protocol
IPS	In-Plane Switching
IPSW	Data format
ISI	Institut für System- und Innovationsforschung
ISO	International Organization for Standardization
ITE	Information Technology Equipment
ITO	Indium-Tin-Oxide
IZM	Institut für Zuverlässigkeit und Mikrointegration
JRC	Joint Research Centre
kWh	Kilowatt Hour
LCA	Life Cycle Assessment
LCD	Liquid Crystal Display
LCO	Lithium-Cobalt-Oxid
LDO	Low Dropout
LDPE	Low Density Polyethylene
LED	Light Emitting Diode
LGA	Land Grid Array
LIB	Lithium-Ion Battery
LLCC	Least Life Cycle Cost
LNA	Low Noise Amplifier
LRA	Linear Resonant Actuator
LTE	Long Term Evolution
mAh	Milliampere Hour
MCU	Microcontroller Unit
MEErP	Methodology for the Ecodesign of Energy-related Products
MIL-STD	United States Military Standard
MLC	Multi-Level Cell
MLCC	Multi-Layer Ceramic Capacitors

MoDeSt	Produktzirkularität durch modulares Design – Strategien für langlebige Smartphones
NAND	Not And
NFC	Near-Field Communication
NiMH	Nickel-Metal Hydride
NOR	Not Or
ODM	Original Design Manufacturer
OECD	Organisation for Economic Co-operation and Development
OEM	Original Equipment Manufacturer
OHS	Occupational Health and Safety
OLED	Organic Light Emitting Diode
OPE	Organophosphate Esters
OS	Operating System
PA	Power Amplifiers
PA	Polyamide
PC	Polycarbonate
PCB	Printed Circuit Board
PCR	Post-Consumer Recycled
PCT	Projected Capacitive Touch
PIR	Post Industrial Recycled
PMMA	Poly(methyl methacrylate)
PoP	Package-on-Package
PROMPT	Premature Obsolescence Multi-stakeholder Product Testing Programme
PSRR	Power Supply Rejection Ratio
PSU	Power-Supply Unit
PVC	Polyvinyl Chloride
QFN	Quad Flat No-Lead
rABS	recycled Acrylonitrile Butadiene Styrene
RAM	Random-Access Memory
REACH	Registration, Evaluation, Authorisation and Restriction of Chemicals
RF	Radio Frequency
RJ	Registered Jack
SD	Secure Digital
SDHC	Secure Digital High Capacity
SDRAM	Synchronous Dynamic Random Access Memory
SDXC	Secure Digital Extended Capacity
SIM	Subscriber Identity Module
SMD	Surface Mounted Devices
SME	Small and Medium Enterprise
SoC	System-on-Chip
SOC	State Of Charge
SOT	Small Outline Transistor
SPI	Serial Peripheral Interface
SSB	Solid State Batteries
SSD	Solid State Drive
TB	Terabyte
TBOEP	Tris(2-butoxyethyl) Phosphate

TCEP	Tris(2-chloroethyl) Phosphate
TCIPP	Tris(2-chloroisopropyl) Phosphate
TD-SCDMA	Time Division Synchronous Code Division Multiple Access
TEP	Triethyl Phosphate
TPHP	Triphenyl Phosphate
TPU	Thermoplastic Polyurethane
TWh	Terawatt Hour
UFS	Universal Flash Storage
US	United States
USB	Universal Serial Bus
V	Volt
VITO	Vlaamse Instelling voor Technologisch Onderzoek
W	Watt
WEEE	Waste Electrical and Electronic Equipment
WiFi	Wireless Fidelity
WLAN	Wireless Local Area Network

2. INTRODUCTION

Preparatory studies aim to assess and specify generic or specific ecodesign measures for improving the environmental performance of a defined product group, sometimes in combination with energy label criteria. The ecodesign preparatory studies therefore provide the scientific foundation for defining these generic and/or specific ecodesign requirements as well as energy labelling criteria. The overall objective is to clearly define the product scope, analyse the current environmental impacts of these products and related systems (extended product scope) and assess the existing improvement potential of any measures. The central element of the MEErP (Kemna 2011; Mudgal et al. 2013), being the underlying assessment methodology, is to prioritise today's possible improvement options from a Least Life Cycle Cost (LLCC) perspective. Identification of the improvement options are based on possible design innovations, Best Available Technologies (BAT) for the short term and Best Not yet Available Technologies (BNAT) for long term, that can help in mitigating the impacts of these products. Policy options are assessed through a scenario analysis and the different outcomes have to be evaluated from the perspective of the EU targets, taking into account potential impacts on the competitiveness of enterprises in the EU and on the consumers.

Task 4 covers the assessment of current and future product technologies in the EU market at different life cycle stages, i.e. production, distribution and end-of-life. This information is used to establish "base-cases" for average products in the established product categories in Task 5. Also Best Available and Best Not yet Available Technologies (BAT, BNAT) are identified which will be the basis for modelling in Task 6. Most of the environmental and life cycle cost analyses throughout the rest of the study are built on base-cases and the technology analysis serves as the point-of-reference for Tasks 5, 6, and 7.

3. SUBTASK 4.1 – TECHNICAL PRODUCT DESCRIPTION

The objective of this subtask is the technical description of the product, the typical specifications of the hardware elements and the functional spectrum provided by application software. First, an analysis on the product level then on the component level is provided. There are overlaps between both views as the components have to interact with and are embedded in the whole system.

3.1. Average Technology: Products

3.1.1. Mobile phones

Due to some major design differences the technology of smartphones and feature phones are explained in separate sub-chapters. The market segment of smartphones is characterised by significantly faster technology changes compared to feature phones.

3.1.1.1. Smartphones

The overall composition of an exemplary smartphone is depicted in Figure 1, with main sub-assemblies as follows (from top left to down right):

- Cover glass
- Display panel (backside view with shielding and display PCB)
- Plastic frame and rear camera
- Backside cover

- Battery
- Mid-frame (Magnesium, aluminium or plastic)
- Main printed circuit board (PCB) and shieldings
- Front camera, cables, microphone, sub-board with USB connector

This is just one exemplary smartphone design. Others are found as well and are characterised further below in 3.2.

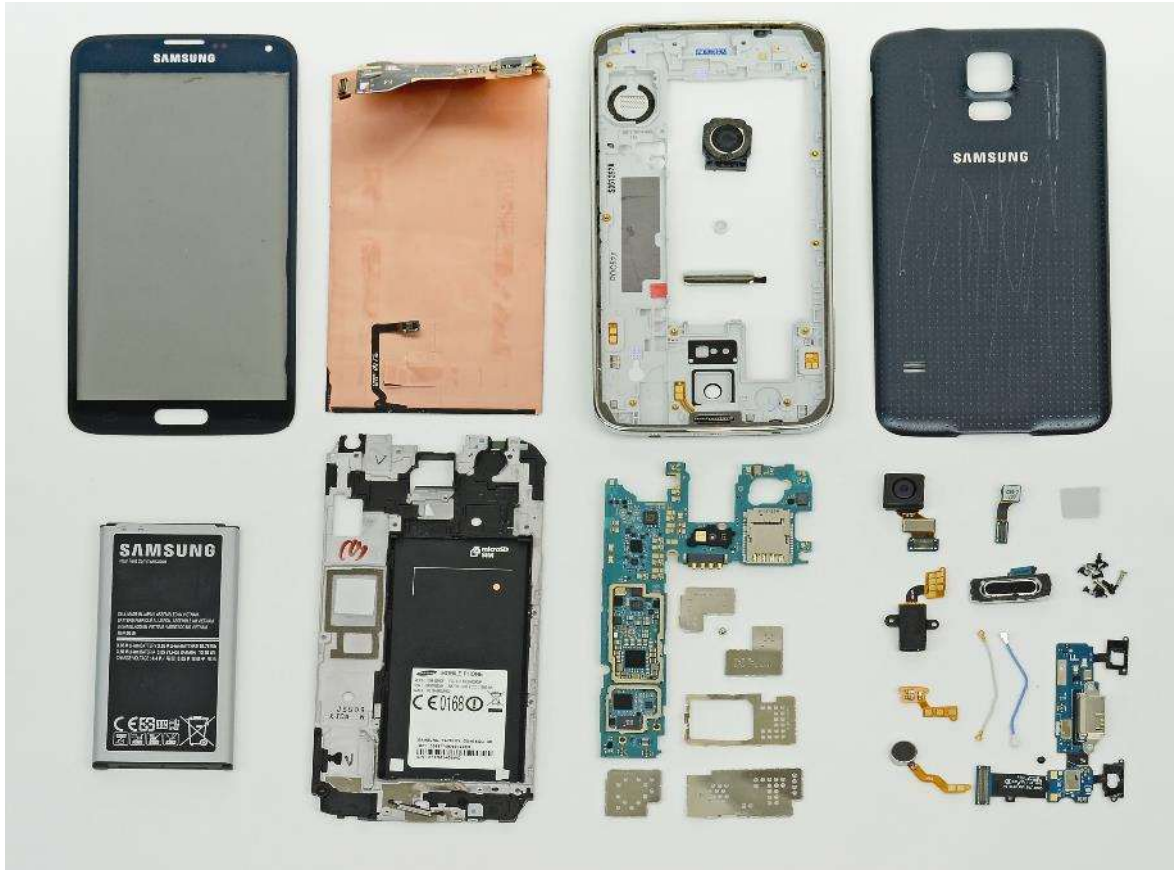

Figure 1: Teardown of a smartphone (Samsung Galaxy S5)

Main smartphone functions correlated with identified user needs and required characteristics have been compiled by DG JRC (Cordella et al. 2020) in the following Table 1.

Table 1 : Smartphone's functions and related characteristics (Cordella et al. 2020)

Function	User needs	Required characteristics
Secure access	<ul style="list-style-type: none"> - Security of access / access restriction - Ease of access 	<ul style="list-style-type: none"> - Access recognition / restriction (e.g. passcode, fingerprint sensors, face ID)
Connectivity	<ul style="list-style-type: none"> - Reliable and fast voice / data connection - Internet access - Availability of different connection options (including ability to provide network access to another device and ability to connect with other devices) 	<ul style="list-style-type: none"> - Cellular Band communication - Wi-Fi Network connection - Infrared/blue-tooth connection - NFC (near-field communication) connection - GPS connection - Tethering - USB/cable connection

Function	User needs	Required characteristics
Communication, user interface and multimedia reproduction	<ul style="list-style-type: none"> - Ability to communicate (send and receive information) via audio, photo and video, and keyboard / touch - Ability to receive/provide notifications via screen / audio / vibration - Ability to take quality photo/video in a wide range of lighting conditions - Ability to support communication apps (such as for video calling, messaging, email) - Ability to adapt display / touchscreen for different phone orientations 	<ul style="list-style-type: none"> - Microphone - Speaker - Headphone connector - Keyboard and/or touch-screen - Functional display and touch screen (size, resolution, color and luminance) - Integrated photo and video-camera (rear and front) - Vibration motor - Accelerometer / gyroscope / proximity sensor
Data storage and processing	<ul style="list-style-type: none"> - Adequate capacities for storage and processing of data (including media) 	<ul style="list-style-type: none"> - RAM and HD capacities
Portable operability	<ul style="list-style-type: none"> - Ability to connect to mains for charging - Ability to connect to other devices for charging and data transfer (e.g. laptop) - Battery that holds charge for a certain time 	<ul style="list-style-type: none"> - Rechargeable battery - External power supply unit - Connector(s) - Duration cycle of the battery
Longevity	<ul style="list-style-type: none"> - Software that is freely updated and maintained for security updates - O/S that supports users' applications - Product that is reliable (electronics) and resistant to typical stresses (e.g. scratches, drops) - Battery that is functional (measured as capacity) over time and replaceable - Product that can be easily repaired and upgraded 	<ul style="list-style-type: none"> - Updatable operating system and software - Resistance to stresses - Longevity of battery - Ease of repair and upgrade

(a) Technical characteristics and market segments

Smartphones entering the market are often classified into flagship devices, mid-range devices, and entry-level devices. These terms are useful to differentiate market segments, however, the classes are not differentiated using clearly defined criteria. The sales price on market entry is often used as one criterion, and while the price range does approximate the specifications, it is also influenced by the OEMs individual marketing strategy, and other factors separate from the device itself. The other criteria are commonly the technical specifications. Flagship / premium / high-end devices commonly feature the latest System-on-Chip (SoC), a relatively large amount of Random-Access Memory (RAM) and internal storage, higher resolutions displays. Build quality and materials are also used as criteria. Further, those devices commonly feature the latest feature on the market, such as curved displays, best cameras, latest

software, etc. The market segments listed below are a momentary snapshot as the borders between segments are highly dynamic. Features from high-end will proliferate over time into lower market segments.

Table 2 : Smartphone market segments (typical specifications)

Classification / Criteria	Entry-level, low-end	Mid-range	Flagship, Premium, High-end
Price range	Low (e.g. < 200€)	Medium (e.g. 200-600€)	High (e.g. > 600€)
SOC	Lower no. of cores, speed	Medium no. of cores, speed	High no. of cores, speed, latest features (e.g. 5G support)
RAM	Low (e.g. 2-6 GB)	Medium (e.g. 4-8 GB)	High (e.g. > 8 GB)
Storage	Low (e.g. ≤ 32 GB)	Medium (e.g. 64 GB, occasionally 128 GB)	High (e.g. ≥ 128 GB)
Display size	Up to 6"	5 to above 6"	Larger than 6"
Display resolution	Low (e.g. < 1080 px)	Medium (e.g. < 1440 px)	High (e.g. 2k, 4k)
Display refresh rate	Low (e.g. 60 Hz)	Medium (e.g. 60-90 Hz)	High (e.g. > 90 Hz)
Body materials	Plastic	Metals, glass, plastic	Metals, glass, ceramics
"Latest features"	Fewer features	Only subset of features	Wireless charging, IP rating, better cameras, more cameras, longer software support

An analysis of the development of technical specifications and smartphone design features over the past decade has been performed in the framework of the PROMPT project (Clemm et al. 2020). The analyses are based on market data from Counterpoint Research that list the market share and sales volumes of the best-selling smartphone models for each year in wider Europe. This data was complemented with technical specifications and design features for each listed model and weighed with the market data to illustrate the features of smartphones entering the market over the course of the past ten years. This data can be used to better understand the evolution of the product group smartphones and may serve as a starting point to forecast developments in the future. The data covers between 41 % and 72 % of the total smartphone market in Europe.

This is complemented by a similar analysis based on a different data set. In the framework of the German research project MoDeSt a data set of 9,600 smartphone models and their technical specification was analysed (Proske et al. 2020a) . Different from the numbers from (Clemm et al. 2020), these data does not take into account market shares and sales figures, but is analysed per model.

Storage / memory

Data in Figure 2 is shown for the market average (green) as well as the highest and lowest amount in smartphone among the best-selling devices of each year. In both cases, the gap between the phone with the highest amount of RAM or internal storage (in cases of several configurations, the maximum configuration is displayed) has been increasing over time, showing a large gap between higher and lower spec devices. The growth in Gigabytes has been near exponential in the phones with the highest amount

of RAM and internal storage. Figure 3 shows a similar trend with lower maximum values. This can be explained by the fact that for devices which are sold with different storage configurations, the lower capacity is taken into account. The differentiation according to price segments shows that high-price devices also come with higher storage and memory capacities.

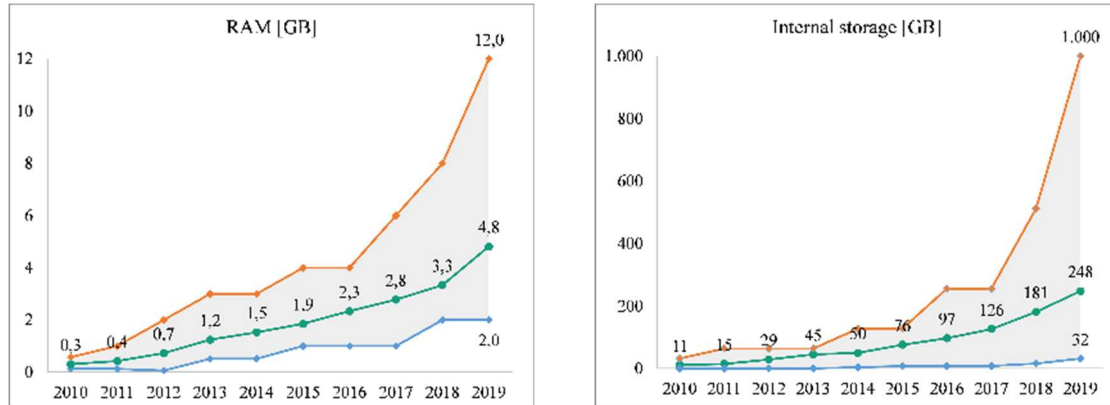

Figure 2: Development of the amount of RAM and internal storage employed in smartphones between 2010 and 2019 (Clemm et al. 2020)

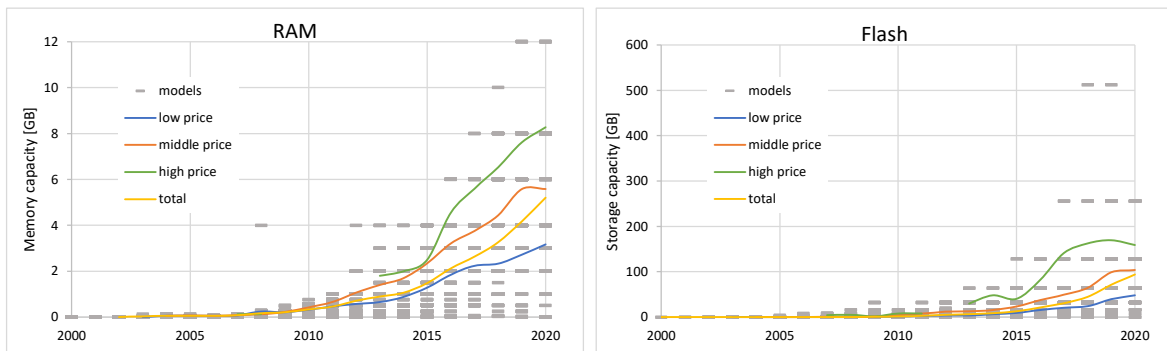

Figure 3: Development of the amount of RAM and internal storage employed in mobile phones between 2000 and 2020 per price category (Proske et al. 2020a) ¹

In terms of market share of sold units an OEM provided the following statistics on market developments in recent years, confirming the trend towards larger built-in storage capacity. The observed trend that more models with higher storage capacity enter the market is also mirrored by the data in Figure 4, but storage capacities of 256 GB and above do not play a major role in terms of sales yet. The market is almost equally shared in 2019 by 32, 64 and 128 GB configurations. The low market share of 256 GB and above seems to suggest, that even flagship phones are bought mostly with only a moderate memory specification – as this apparently is a major cost factor.

¹ Grey bars indicate individual models, the coloured lines represent the average of the market segments

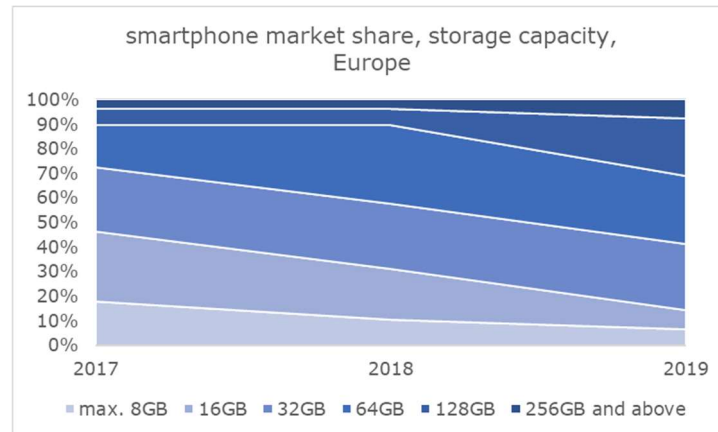

Figure 4: Development of internal storage employed in smartphones, 2017-2020, market share (data provided by an anonymous OEM)

From an environmental perspective the tendency to purchase a smartphone with rather a lower memory capacity instead of going for maximum storage is beneficial as it reduces the environmental cradle-to-gate impact of the device. On the other hand storage might be a limiting factor at a certain point of time, reducing product lifetime and making reuse less attractive.

Display sizes and designs

Data in Figure 5 is shown for the market average (green) as well as the largest and smallest value among the best-selling smartphones of each year. The average display size in the market has increased from 3.2 to 6 inches within ten years. The average screen-to-body ration has increased from 46 % in 2010 to 81 % in 2019. The increase in both features has been relatively linear. A similar trend is shown in Figure 6 for low and middle-priced devices. High-priced devices show higher variances in the trend which might also be caused by the lower number of models in that price segment. It is also shown that the average bigger displays are a trend across branches and price segment and smaller devices became a niche.

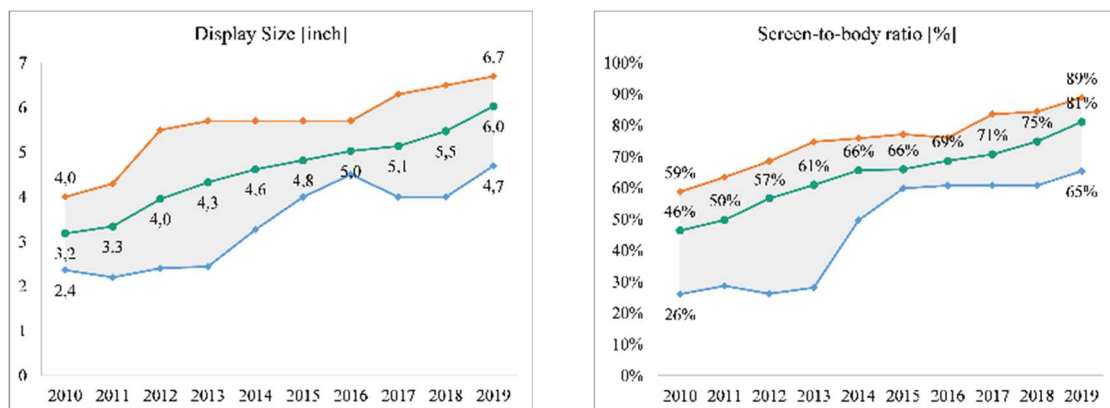

Figure 5: Development of the display size and screen-to-body ration in smartphones between 2010 and 2019 (Clemm et al. 2020)

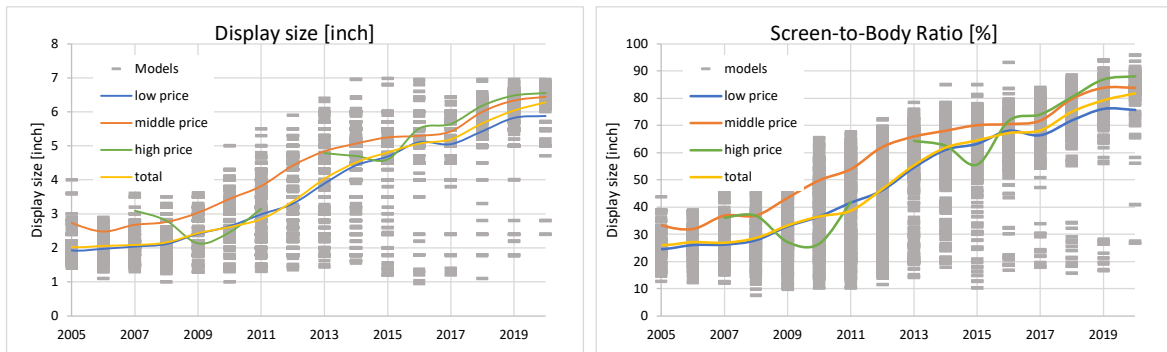

Figure 6: Development of the display size and screen-to-body ration in mobile phones between 2005 and 2020 per price segment (Proske et al. 2020a)

High-end devices feature a higher weight than mid- or low-range devices of same size. This might be due to a higher share of devices with metal housing instead of plastics, additional glass for the backside and a larger battery in terms of capacity *and* weight.

Parallel to the increasing display size, the absolute weight of the device increased only slightly as weight per display size dropped for all price segments (Figure 7).

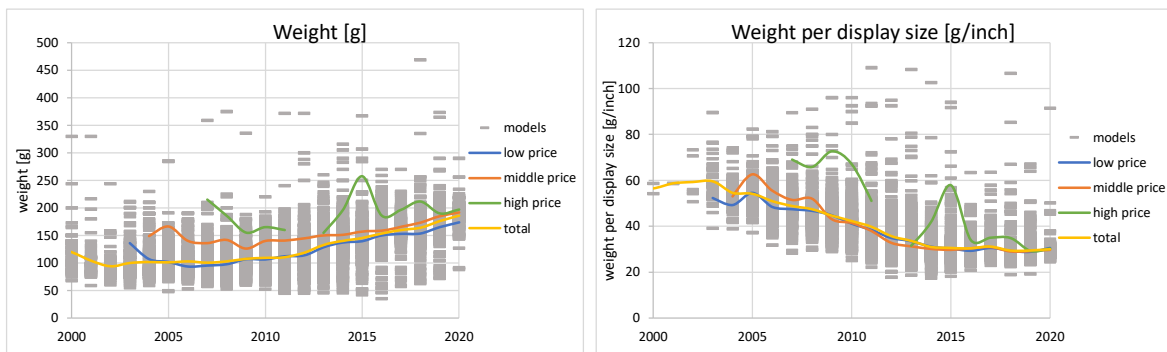

Figure 7: Development of weight and weight per display size in mobile phones between 2000 and 2020 per price segment (Proske et al. 2020a)

In 2019 the market share of non-traditional display designs increased significantly: Whereas in 2017 traditional designs with display bezels to cover the edges of the LCD panel and to accommodate selfie-camera and loudspeaker outlet represented almost 100% of the market, two years later this share dropped to below 30%²: Various designs emerged for an edge-less display – but design solutions still had to be found for the selfie-camera, which made it into a notch, “water drop” or through a punch hole. The display panel designs had to be adapted to allow for these more complex designs (Figure 8). The Hole-punch design had only 8.2% of the market in 2019, but according to an OEM it is prognosed be the next popular design in the next several years.

² Market data shared by an OEM in response to the stakeholder consultation

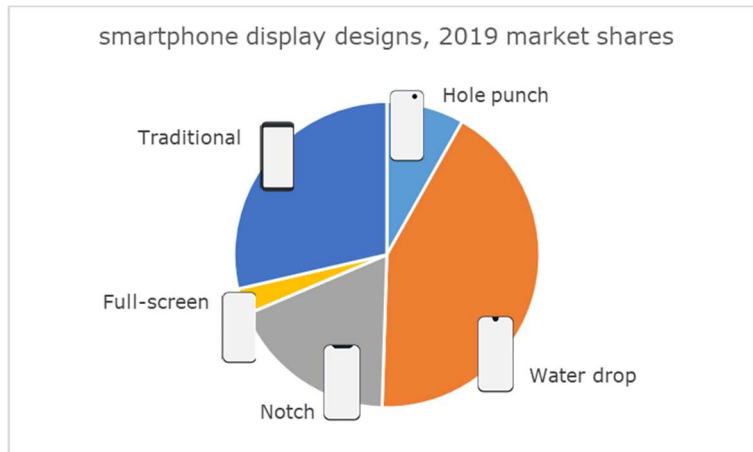

Figure 8: Smartphone display designs – market share, 2019, Europe

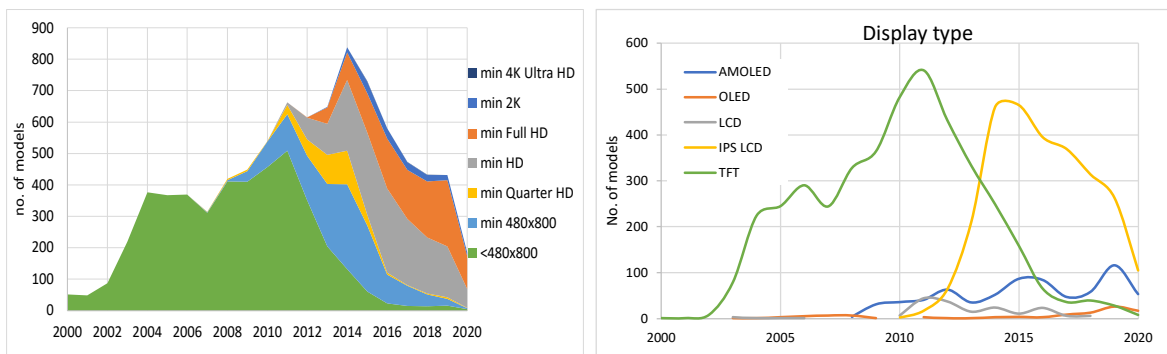

Figure 9: display type and resolution of mobile phones between 2000 and 2020 (Proske et al. 2020a)

In Figure 9 and some of the following figures note, that the y axis refers to the absolute number of models published per year. As the source is from early 2020, only few models are presented for 2020.

The display resolution of devices is increasing. Since 2016, the majority of released models had HD resolution. IPS LCD and AMOLED are currently the most widely used display technologies.

Network connectivity

Figure 10 shows the mobile network generation capability of released devices. Since 2016, the majority of devices has 4G (LTE) capability, but still 3G only devices were released in 2019.

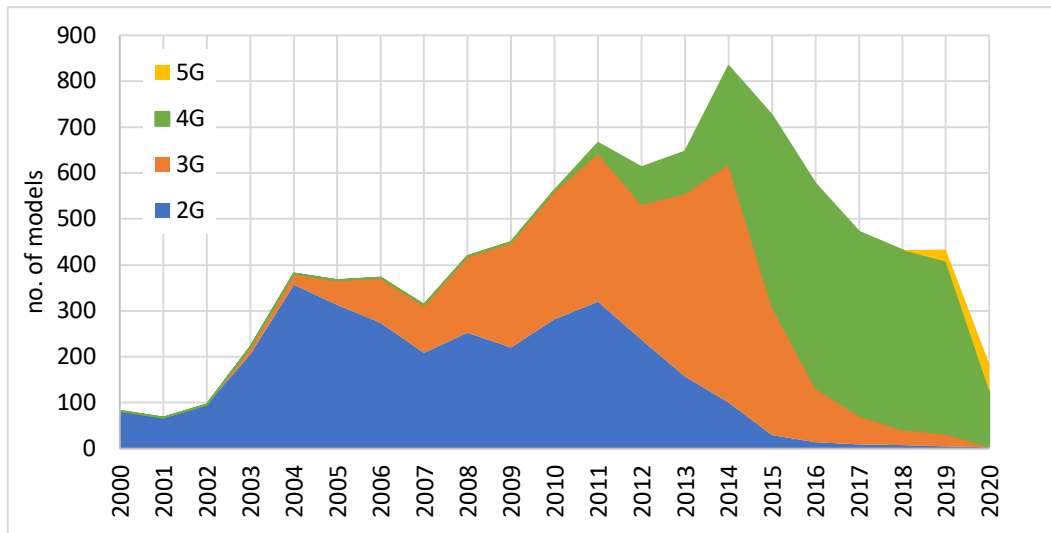

Figure 10: Mobile network generation technology in mobile phones between 2000 and 2020 (Proske et al. 2020a)

Forecasted market development regarding 5G capability of smartphones as shared by one OEM in the course of the stakeholder consultation indicate a moderate change towards 5G phones in the coming years. It will take 3 years until 2023 before more 5G phones are sold than 4G-only phones. This market forecast also does not predict a significant increase of total smartphone sales fuelled by 5G introduction (Figure 11).

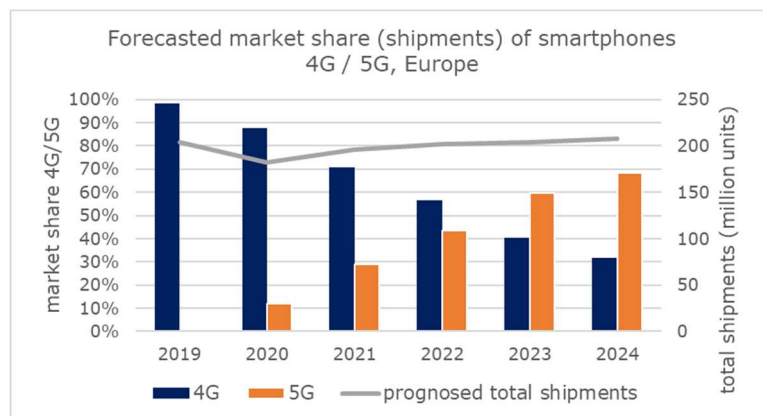

Figure 11: Smartphones - 5G market penetration forecast (data provided by an anonymous OEM)

Case joining techniques

Berwald et al. (Berwald et al. 2020) used the same dataset than Clemm et al. (Clemm et al. 2020) to analyse smartphone case joining techniques applied to the best-selling smartphones in Europe. Figure 12 shows that joining techniques that are considered to be reversible (clips, snapfits, screws) have been largely displaced by adhesives in the course of the last years³.

³ Market data of the best-selling smartphones in Europe between the years 2010 and 2019 were complemented with data on joining techniques applied to the devices external housing for this illustration. It has to be noted that the underlying market data cover up to 25 best-selling devices in each year. The data therefore covers between 41 % and 72 % of the overall European market and generally includes the high-end

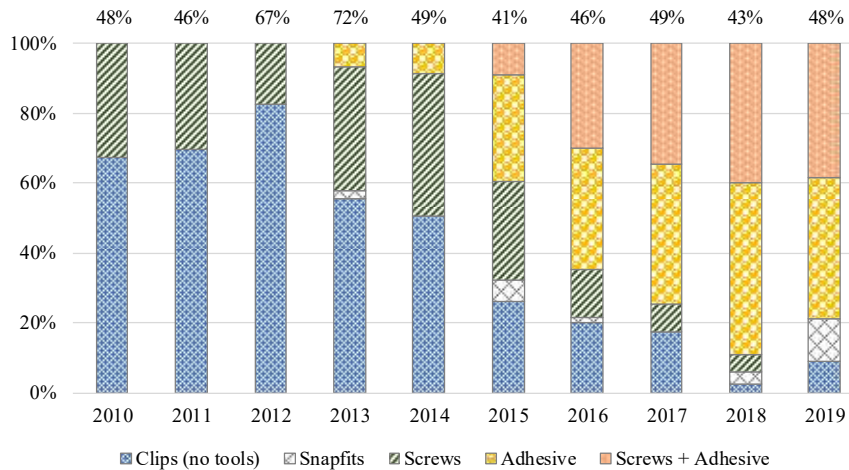

Figure 12: Evolution of smartphone case joining techniques applied to the best-selling smartphones in Europe (based on market data from Counterpoint Research; market coverage denoted on top of data columns).

While this design trend can have negative implications for repair and recycling of smartphones, it may have positive effects on the robustness of the devices (e.g. through better ingress protection).

Further investigations into the evolution of the disassembleability of smartphones showed that today most of the batteries are joined into smartphones through adhesives. This contrasts the design ten years ago where most of the batteries were not glued and could be removed more easily. Figure 13 shows the trend towards using adhesives to fix the battery in smartphones. The diagram makes a distinction between adhesives (e.g. liquid adhesives; double-sided tape) and pull tabs. The latter is a specific type of double-sided tape which loses its adhesive properties when it is stretched. This property facilitates the removal of batteries without the need of using thermal energy or chemical solvents Berwald et al. (2020).

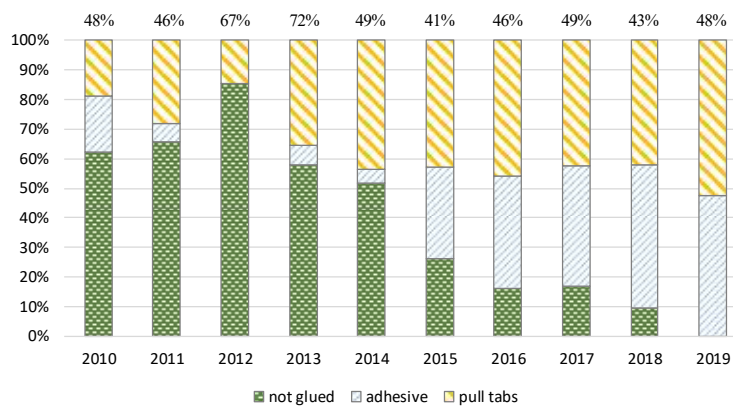

Figure 13: Trend towards the use of adhesives to fix the battery within smartphones among the best-selling smartphones in Europe (based on market data from Counterpoint Research; market coverage denoted on top of data columns)

“flagship” models of the most popular manufacturers, in addition to particularly popular medium-range and low-end devices. Market coverage for each year is denoted on top of the data columns in the diagram.

Again, this practice may have negative implications for repair and recycling of smartphones, as batteries are more difficult to remove. On the other hand, using adhesives might increase the robustness of the devices, since the batteries are firmly held in place and might thereby be better protected from shocks and vibration.

Battery capacity and integration

Figure 14 shows the market average (green) as well as the largest and smallest value among the best-selling smartphones of each year. The average battery capacity in the market has increased relatively linearly from approx. 1.300 mAh to 3.300 mAh in the course of ten years. There is a considerable variance between the highest and lowest capacity among the best-selling phones in each year, particularly in the more recent years.

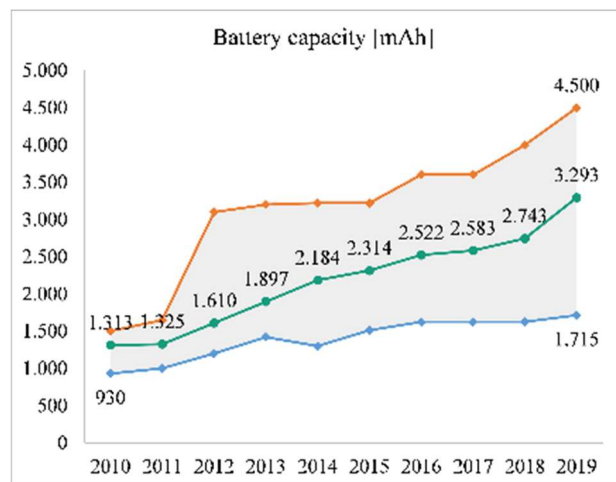

Figure 14: Development of the battery capacity in smartphones between 2010 and 2019 (Clemm et al. 2020)

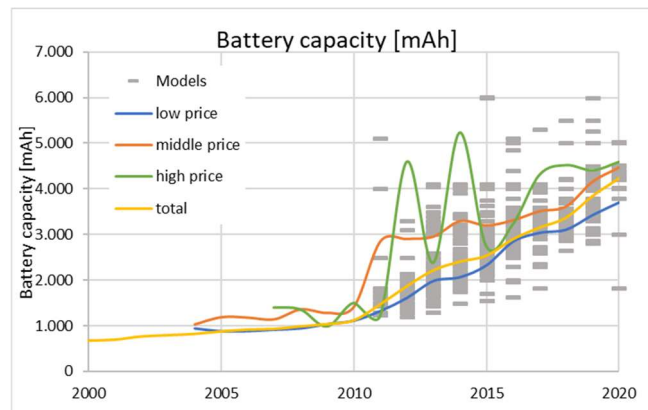

Figure 15: Development of the battery capacity in mobile phones between 2000 and 2020 per price segment (Proske et al. 2020a)

Until 2011, the majority of models had user-replaceable batteries. Since then the number of new models dropped very fast. There are still models with user-replaceable batteries released, but there are rare and non in the high-end segment of smartphones.

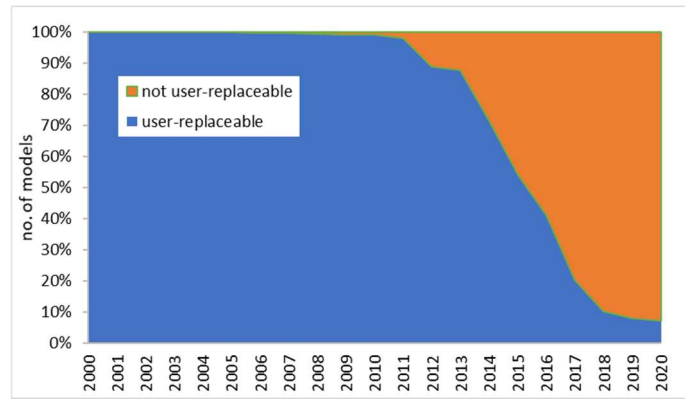

Figure 16: share of user-replaceable and not user-replaceable batteries in mobile phones between 2000 and 2020 (Proske et al. 2020a)

Battery integration and IP rating

Indeed, plotting together the market share of smartphones with embedded battery and phones with IP rating (water and dust ingress protection) shows the same trend (Figure below). It can be assumed that the practice of embedding batteries and sealing the external housing with adhesives allows more models to successfully be reach higher IP ratings (commonly IP67 or IP68). However, as not all devices with embedded batteries feature a (high) IP rating, these statistics suggest that there are also other motivations for embedding batteries than a high IP rating.

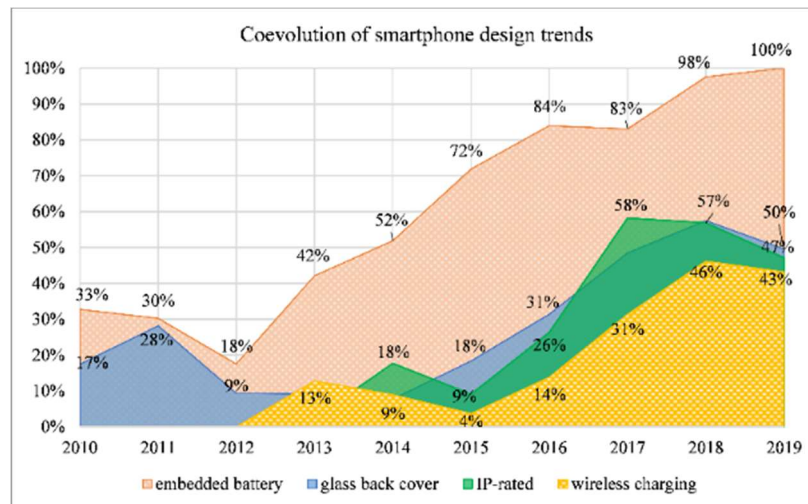

Figure 17 : Coevolution of the smartphone design trends embedded battery, glass back cover, IP rating and wireless charging (Clemm et al. 2020)

Glass back cover

Since the release of the iPhone 4 in 2010, more and more smartphones have been equipped with a glass back cover. Around 50% of best-selling smartphones in Europe have nowadays a glass back cover, as compared with less than 10% in 2010 (Figure 17).

In Figure 17 it can be observed that the share decreased slightly after 2017. One explanation for this trend could be that in 2018 and 2019 a number of mid-range devices with a plastic back cover gained higher market shares (glass being considered a "premium" material, mostly applied to flagship models).

Using glass comes with advantages and disadvantages. Glass is relatively scratch-resistant, it ensures good signal reception (e.g. Wi-Fi, LTE, and Bluetooth) and it can be used with wireless charging. On the other hand it is a relatively fragile material and can break when an overload is induced (e.g. through a drop). Glass can be chemically strengthened through an ion-exchange process. Major producers are Gorilla, Sapphire and Dragontrail. According to Corning, smartphones with a Gorilla Glass 6 can survive at least 15 drops on a rough surfaces from a height of one metre (Corning 2020b).

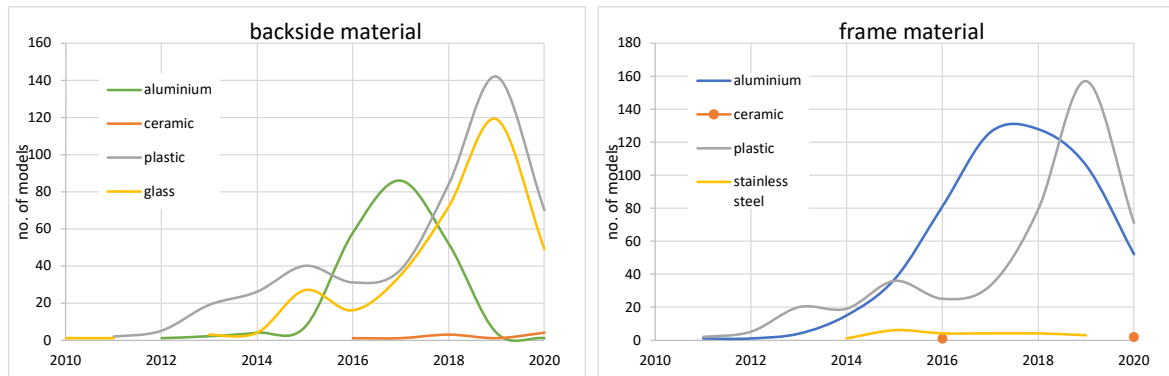

Figure 18: Development of backside and frame material in mobile phones between 2010 and 2020 (Proske et al. 2020a)

As shown in Figure 18, backside and frame material consist mostly of plastic and glass for current devices when looking at market releases without taking into account market share. Aluminium had a peak in 2017. Less models with metal backside might be caused by the parallel trend to wireless charging, which does not work with a metal back plate. Note that y axis in the figure refers to the absolute number of models published per year. As the source is from early 2020, only few models are presented for 2020.

Foldables

Over the last years Flexible Hybrid Electronics (FHE) have gained in importance, defining electronic systems that can be bent, stretched and folded while preserving their operational integrity of traditional electronics architectures (Source: iNEMI 2019 Roadmap – Flexible Hybrid Electronics). FHE are evolving in various application areas such as wearables, lighting systems and also display modules (e.g. with smartphones). Companies such as Samsung, Lenovo, Royole, LG or JOLED have released foldable OLED displays. The Motorola Razr and the Galaxy Z Flip are examples of two clam-shell foldable smartphones which were released in 2020.

Since these devices are relatively new on the market, their durability has not been comprehensively assessed in published literature at this point in time. Usually, foldable smartphones come with two non-user-replaceable batteries, and as such the battery lifetime will directly limit the lifetime of the phone as a whole. In addition, particular concerns can be related to the longevity of the flexible panels, the hinges and the material covering the screen. First tests conducted by consumer organisations show that while the hinge withstands more than 30,000 opening / closing cycles, it performs less good in drop tests (UFC QC 2020). Furthermore, display scratch tests show damages at relatively low levels that do not occur with strengthened glass (Nelson 2020).

When it comes to the reparability of folded devices, iFixit gave the Motorola Razr a reparability score of 1/10, calling it the “most complicated phone-based contraption we’ve ever taken apart” (iFixit 2020). Likewise, the Galaxy Z Fold has received a relatively low iFixit reparability score of 2/10 (iFixit 2019).

(b) Material composition

DG JRC (Cordella et al. 2020) already researched comprehensively material composition data with the following findings⁴: Data available for 32 models of smartphones produced by Huawei (as of January 2019) shows a range in weight from 142.4 g to 232 g. The battery represents around 25-30% of the product weight and together with glass and ceramic materials⁵ represent more than 50% of the smartphone mass.

Weight of 15 models of smartphones produced by Apple (as of January 2019) ranges from 112 g to 208 g, with an apparently higher weight for newer models. The relative weight of batteries has passed from about 25% for older models to about 40% for the newest ones⁶. Stainless steel is reported to be used more than aluminum and plastics. However, a variation in the use of different materials over time can be observed.

The weights of smartphone models from Fairphone (170 g for a size of 75.5 cm²) and Samsung are also included in the range described above.

Based on the available data, the weight of a smartphone could be estimated approximately as 29 g per display size inch (+/- 15%).

The mass of a smartphone in general consists of metals (mainly aluminum, copper and iron/steel alloys, but also minor quantities of other elements used for specific applications because of their properties, including rare earth elements and conflict minerals), glass and ceramics, plastics, and other materials.

Screens are manufactured mainly from aluminosilicate glass, a mixture of aluminum oxide and silicon dioxide, which is then placed in a hot bath of molten salt. These are pressed together when the glass cools, producing a layer of compressive stress on the glass and increasing its strength and resistance to mechanical damage. A thin, transparent, conductive layer of indium tin oxide is deposited on the glass in order to allow it to function as a touch screen.

The vast majority of smartphones use lithium ion or lithium polymer batteries. These batteries tend to use lithium cobalt oxide as the positive electrode in the battery (though other transition metals are sometimes used in place of cobalt), whilst the negative electrode is formed from carbon in the form of graphite. For further details see 3.2.3.

A wide range of elements and compounds are used in the electronics of a phone. The main processor of the phone is made from pure silicon, which is then exposed to oxygen and heat in order to produce a film of silicon dioxide on its surface. Parts of this silicon dioxide layer are then removed where current is required to flow. Silicon does not conduct electricity without being doped with other elements; this process involves the silicon being bombarded with a variety of different elements, which can include phosphorus, antimony, arsenic, boron, indium or gallium. Different types of semiconductor (P or N) are produced depending on the element used, with boron being the most common type of P-type dopant. The micro-electrical components and wiring in the phone are composed mainly of copper, gold, and silver. Tantalum is also

⁴ analysis has been updated and revised where appropriate with own insights

⁵ Ceramics are used in minor amounts only, mainly in capacitors, and can be considered a technically important, but minor constituent of smartphones

⁶ With growing device sizes internal components do not need to be larger, so additional volume is typically then allocated to increase battery capacity

used, being the main component of some capacitors (Figure 19). Contrary to other passive components tantalum capacitors remained largely of the same size in past years as the production technology is different than for, e.g. multi-layer ceramic capacitors (MLCCs), which are cut from a substrate. The number of tantalum capacitors per phone is varying, but typically in the range of 2 – 7, but with tantalum capacitors ranging from 13 in the Fairphone 2 to none in the current Fairphone 3 and several other smartphone models.

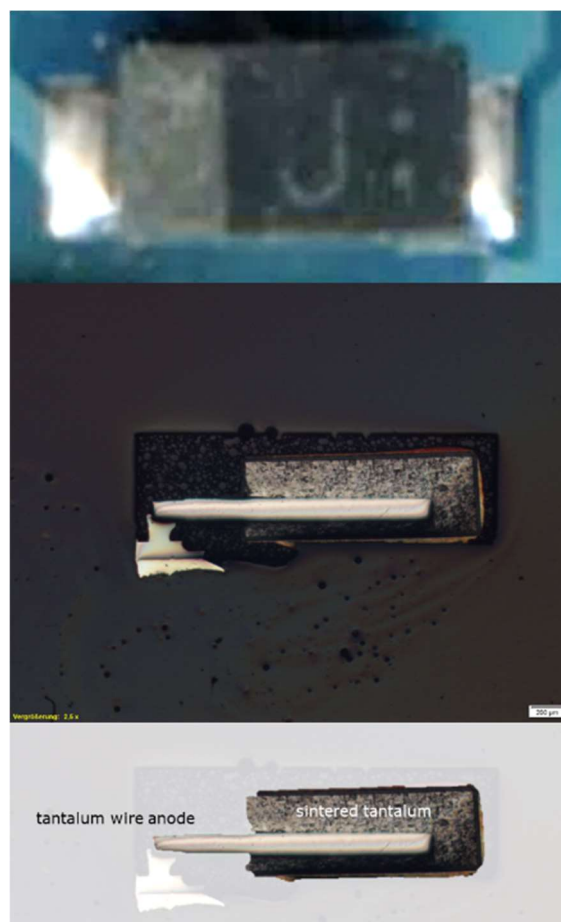

Figure 19 : Tantalum capacitor, top-view and cross-section, tantalum containing parts highlighted

A range of other elements, including platinum and palladium are also used. Solder is used to join electrical components together. Solder alloys with tin as main constituent, silver and copper are in use.

Besides tantalum, gold and tin another metal in smartphones, cordless phones and tablets potentially originating from conflict minerals is tungsten, which is used in very minor amounts in semiconductors and in more significant amounts in the vibration alert modules. However, overall use of tungsten in mobile devices is only a marginal share of the global total tungsten metal use. Most commercially available smartphones contain coin-shaped linear resonant actuators (LRAs). The tungsten-containing component, the tungsten ring, is mounted on other components inside a metal housing. Figure 20 below shows a disassembled linear actuator and all the components it contains: The metal housing, the tungsten ring, a wave spring, the NdFeB magnet as well as a copper coil and the adhesive foil. The tungsten content based on an analysis of models from 2012 – 2016 ranges between 0,35 g and 1,2 g per smartphone (Nissen et al. 2019).

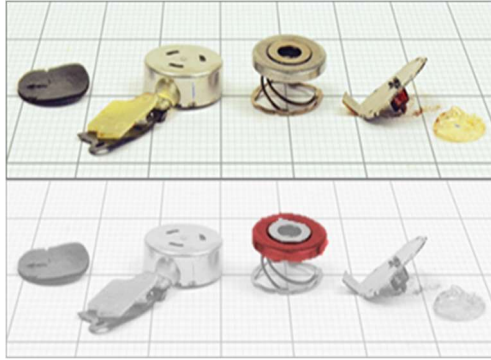

Figure 20 : Disassembled vibration motor of a 2012 smartphone model, tungsten part marked in red

Cobalt is used as cathode material in Li-ion battery chemistries. A large portion of the mined cobalt production (around 50%) is in the Democratic Republic of Congo, where a significant amount of cobalt is mined by unregulated artisanal and small-scale mining practices (Cordella et al. 2020).

Indium is used as transparent indium-tin-oxide layer (ITO) in displays, on average 0.01 g per smartphone (Manhart et al. 2016).

Gallium is used in Power Amplifiers (PAs), typically as GaAs III-V semiconductor material, to amplify voice and data signals to the appropriate power level allowing their transmission to the network base-station and in LED-backlights. The use of gallium is on average 0.0004 g per smartphone (Manhart et al. 2016).

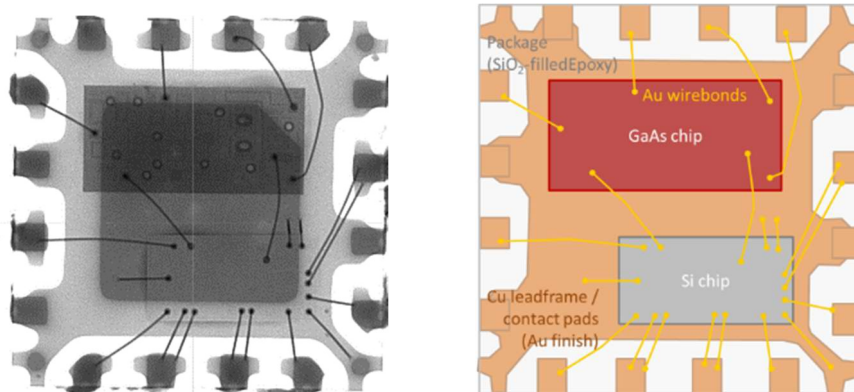

Figure 21: WLAN module with GaAs and Silicon chips in one package (Quad Flat No-Lead package; top-view X-ray, left, and schematic drawing, right)

The main materials of interest for material recycling are copper and precious metals. These metals represent the majority of the material value of mobile phones, but also tablets. Compared to feature phones (data from a recycler as of 2015) the content of these metals is lower in smartphones⁷ (Bookhagen et al. 2018): The gold content is lower, silver content is significantly lower and also the palladium content in smartphones is only ¼ compared to conventional mobile phones (Figure 22). Copper content went down as well. This is assumed to be an effects of designing out the physical keyboard, which had a larger board area with corrosion resistant gold finish. Also progress was made to reduce layer thicknesses as such and to replace Pd-containing MLCCs (Multi-layer ceramic capacitors) by those, which do not contain precious metals. The printed circuit board assembly contains a large range of further

⁷ data from devices as of 2012

metals, which however to a large extent cannot be recovered in state-of-the-art smelters, nor do they represent a significant share of the overall material value. The PCB substrate is made of glassfiber reinforced epoxy resin.

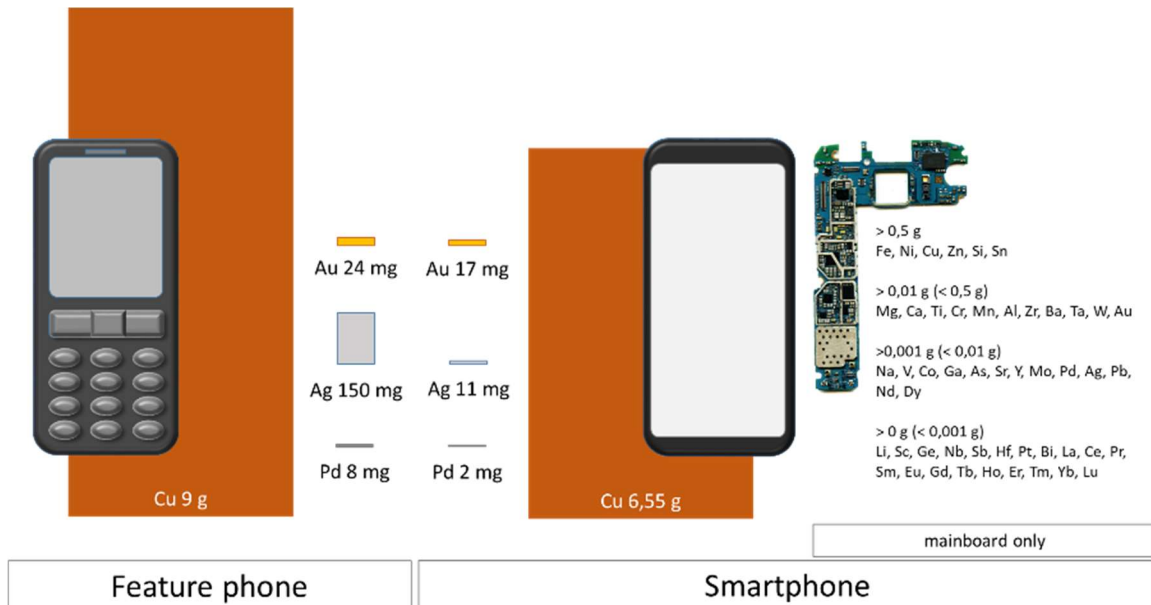

Figure 22 : Material content of selected metals in conventional mobile phones and smartphones (data source: Bookhagen et al.)

The microphone and speaker of the phone both contain magnets, which are usually neodymium-iron-boron alloys, though dysprosium and praseodymium are often also present in the alloy. These are also found in the motor of the vibration unit of the phone, where tungsten is used as rotating component.

The casing can be made of metal or plastic, or a mix of the two.

Plastics used in smartphones, mobile phones and tablets are typically:

- ABS (acrylonitrile butadiene styrene): housing parts
- PC (polycarbonate): housing and sub-housing parts
- TPU (thermoplastic polyurethane): housing parts, wire and cable jacketing
- TPE (thermoplastic elastomers): cables
- PMMA (poly methyl methacrylate): camera covers, transparent display covers in e.g. cordless phones
- PA (polyamide): frame splitter
- PP (polypropylene) : wires
- Silicone rubber: soft keyboards of feature phones and cordless phones

Flame retardants in smartphone components have been found by Zhang et al. (Zhang et al. 2019), in an research on selected smartphones sold 2015 or before. The analysis showed, that halogenated flame retardants are not in use anymore, which also corresponds with several OEM policies. Instead, results demonstrated that organophosphate esters (OPEs) were the principal FRs in these smartphone devices. Triphenyl phosphate (TPHP) was the primary flame retardant in the smartphones, followed by tris(2-butoxyethyl) phosphate (TBOEP), 2-ethylhexyl diphenyl phosphate (EHDPP), triethyl phosphate (TEP), tris(2-chloroethyl) phosphate (TCEP), and tris(2-chloroisopropyl) phosphate (TCIPP), respectively. The average smartphone contained 3.37×10^7 ng TPHP/unit, which was concentrated in the phone screen. Other

components, where these flame retardants were found, are battery wrapping paper, circuit board plastic, label plastic, phone inner shell, phone case, copper wire plastic, and cushion. Zhang et al. estimated the annual amount of Σ OPEs and TPHP in smartphones used globally to be 53.5 and 51.8 tons, respectively. These findings are unexpected as the screen is not particularly at risk to develop heat, which might result in a fire risk, and in the other cases concentrations of flame retardants are so low, that an effective flame retardancy in any case is unlikely⁸. Experts from industry assume that the identified use of organophosphate esters might rather have another function and is not added for flame retardancy purposes. Zhang et al. screened for the large group of organophosphate esters but did not analyse the full spectrum of potentially contained flame retardants: Phosphinates (Li et al. 2014) are another group of flame retardants, which are known to be used in flexible printed circuit boards and charging cables. Xiaomi confirmed as flame retardant in cables phosphinates and melamine cyanurate.

The current trend in smartphone body design seems to be towards the use of high-grade materials (as aluminium or stainless steel) instead of commonly used plastics and also toughened glass are used increasingly to combine a claimed aesthetic design with the required transmissibility for wireless charging. Essential introduced in 2017 a smartphone (PH-1) with a titanium housing and a backside made of ceramics, but with Essential being closed in the meantime and the PH-1 not being sold any further, titanium does not play a role anymore for smartphones.

Table 3 : (Selected) material content smartphone, feature phone

Material	Main application	Content per smartphone (Manhart et al. 2016)	Content per smartphone (Sander et al. 2019)	Content per feature phone (Sander et al. 2019)
Aluminium	case	22.18 g		
Copper	wires, alloys, electromagnetic shielding, printed circuit board, speakers, vibration alarm, battery	15.12 g		
Plastics	case, antenna substrate, module housings, connector housings	9.53 g		
Magnesium	mid-frame	5.54 g		
Cobalt	lithium-ion battery	5.38 g	6.3 g	0.720-8.448 g
Tin	solder paste	1.21 g	0.648 g	1.167 g
Iron (steel)	case, shielding, module housings	0.88 g		
Tungsten	vibration alarm	0.44 g		
Silver	solder, printed circuit board	0.31 g	0.305 g	0.127-0.715 g
Neodymium	magnets of speakers, vibration alarm, camera	0.05 g	0.12 g	0.046-0.118 g

⁸ which is confirmed by an FR expert; for an effective flame retardancy concentration of FR substances needs to be well above 5% in almost all cases

Material	Main application	Content per smartphone (Manhart et al. 2016)	Content per smartphone (Sander et al. 2019)	Content per feature phone (Sander et al. 2019)
	mechanics, cover fixation			
Gold	electronic components, printed circuit board finish, connectors / contact pads	0.03 g	0.03 g	0.05-0.0684 g
Tantalum	capacitors	0.02 g	0-0.0024 g	0.0867 g
Palladium	electronic components, printed circuit board finish	0.01 g	0.011 g	0.01-0.0366 g
Praseodymium	magnets of speakers, vibration alarm, cover fixation	0.01 g		
Indium	display	0.01 g	0.0024 g	0.0018-0,01 g
Yttrium	LED-backlights	0.0004 g	0-0.00001 g	n.a.
Gallium	LED-backlights, RF components	0.0004 g	0.0001 g	0.0047 g
Gadolinium	LED-backlights	0.0002 g		
Europium	LED-backlights	0.0001 g		
Cerium	LED-backlights	0.00003 g		
Others	ceramics, semiconductors... glass	99.29 g		
		160 g		

A list of the most common materials used in smartphones (and tablets) is provided in Table 3. Data has been compiled by Manhart et al. in 2016, main applications have been revised based on our insights. There is some discrepancy to the values found by Bookhagen et al., but this is not a contradiction as variations among different models can be huge, see the tantalum example above.

Additional materials are necessary for packaging, documentation and accessories such as headset, USB-cable, charger, including a quite relevant amount of plastic materials. Packaging is typically made of fibre based material and, to a lower extent, plastic materials (e.g. 110 grams of cardboard and 20 grams of LDPE film) (Proske et al. 2016).

With respect to the origin of materials, many smartphone materials are sourced in China, see the analysis of Apple's list of suppliers in the Task 2 report.

Both the type and the processing of materials used in smartphones are key factors for determining the environmental impacts of devices. For example, it has been reported that the impact on climate change of primary aluminum is about 20 kg CO₂eq per kg of materials when produced from coal-based electricity, and this drops to about 5 kg CO₂eq per kg of materials when produced using hydro-based electricity. Recycled aluminium has an even lower impact on climate change. The carbon footprint of most plastics is instead about 4-5 kg CO₂eq per kg of material (Cordella et al. 2020).

Regarding the use of certain substances, which are under discussion due to potential environmental and health risks under certain conditions the analysis by JRC is still accurate, that manufacturers increasingly phase out such substances (Cordella et al. 2020; Jardim 2017):

- PVC: Due to possible formation of hazardous substances from the incineration of this type of plastic, some manufacturers already a while ago communicated the phase-out of PVC from their products, which anyway never has been relevant for mobile phones except for power cables.
- Beryllium: Beryllium copper is used in electronic and electrical connectors. Beryllium is used as an alloying element in copper to improve its mechanical properties without impairing the electric conductivity. Some manufacturers claim to have phased-out beryllium. Modular designs might make increased use of beryllium copper for springs and connectors (Schischke et al. 2019).
- Antimony: this element is alloyed with lead or other metals to improve their hardness and strength and is used in the electronics industry to make some semiconductor devices, such as infrared detectors and diodes. Antimony trioxide is moreover used for flame retardancy in combination with halogenated flame retardants. Several manufacturers have eliminated the use of Antimony.
- Arsenic compounds: Arsenic compounds have been used in glass of LCDs or other glass parts, but OEMs and display suppliers switched to substitutes a while ago. As III-V semiconductor GaAs is in rather increasing use in mobile devices for RF chips (see gallium above).

3.1.1.2. Feature phones

In contrast to smartphones the technical characteristics of feature phones are less sophisticated: The dimensions are typically smaller with regards to height and width, but devices are thicker, typically. The weight is lower than that of average smartphones. The screen is smaller (and not necessarily touch-sensitive), i.e. typically 2,4" or similar, and physical keys are provided.

Processors in feature phones are less sophisticated as they are mainly defined by the telecom network generation they support. Many feature phones still rely on 2G technology. Similarly RAM is rather small and the same is the case for internal storage. Replaceable batteries and a clipped back cover to access the battery and the SIM slot are common among feature phones.

The housing is made of plastics and only occasionally of metal. Whereas for smartphones an internal frame or the back cover to which major components are attached provides the needed stability, with feature phones the printed circuit board frequently is a mechanically stabilizing element for the whole device and therefore is of a size close to the internal dimensions of the handset (roughly 50 cm²) and significantly larger than needed for the electronics functionality only. As such, it is populated with SMD components only in some areas and complexity is assumed to be 2- or 4-layers. In sophisticated smartphones the mainboard is found side-by-side with the battery and other components and does not fill the full area of the device; in feature phones the mainboard is placed beneath the battery.

The keyboard assembly features a separate printed circuit board substrate (covering roughly 40% of the phone size, i.e. 20 cm²) with the key pads and the actual keys made of plastics on top.

Major parts of a feature phone with indications of materials and weights is provided in Figure 23.



Figure 23 : Feature phones – major parts, materials and weights

3.1.1.3. Use phase power consumption

Power consumption of mobile phones is mainly related to the following components (Pramanik et al. 2019):

- CPU
- Video / image / graphics processing
- RF modems / interfaces: Bluetooth, WiFi, 3G / 4G / 5G, and GPS
- Display / backlight

The relevant modes are:

- Active battery charge
- Maintenance or trickle-charge (mobile phone is connected to the external power supply, but battery is fully charged)
- Power adapter no-load (external power supply is plugged in, but disconnected from mobile phone)

The power adapter no-load mode is already fully covered by the external power supply regulation (see Task 1), and referenced and considered here only for completeness.

The web portal Notebookcheck reviews extensively the performance of smartphones, including power measurements. These measurements are undertaken when the device is connected to the grid, and the battery is fully charged:

- Off: smartphone connected, but switched off
- Standby: smartphone connected, but inactive
- Idle average: smartphone is idle, maximum brightness, additional modules off
- Load average: smartphone runs with maximum brightness, all modules on, Android devices tested with the app "Stability Test" Classic, iOS and Windows 10 mobile devices tested with app Asphalt 8

With this stationary power measurement setting these mode definitions are not suitable to define a typical mobile use scenario, but the power values as such provide important orientation regarding device power consumption.

Measured power consumption values for 500 smartphones is depicted in Figure 24. There are huge differences in these power consumption values among the various models, but display size has only a moderate impact: In load mode as defined by Notebookcheck the average power consumption of a 6,5" phone is only roughly 10% higher than for 5" phone. A similar correlation is observed for idle, where the display is assumed to be the major power consumer.

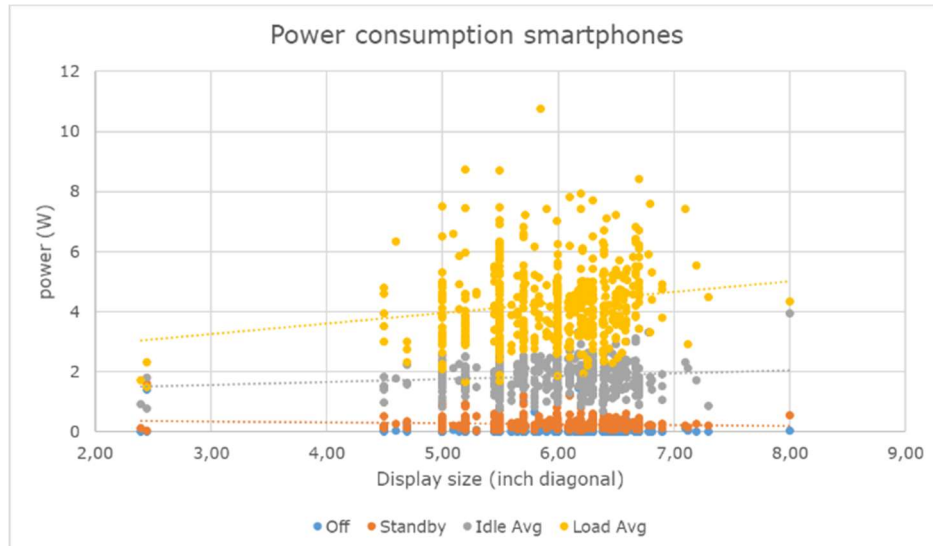

Figure 24 : Smartphones – Power consumption in various modes (Notebookcheck 2020)

There is a huge spread in battery endurance, i.e. how long a mobile phone operates on a full charge. GSMArena tests smartphones with its own test procedure and states an endurance rating in hours for a use profile of 1 hour talk time, 1 hour web browsing, 1 hour video playback daily. The test results for 721 smartphone models are shown in the histogram in Figure 25: Under the given test conditions the spread is between 23 and 186 hours. For orientation, "conventional" flagship devices, such as the Samsung S20 Ultra 5G and the iPhone 11 Pro Max are rated at 87 and 102 hours

respectively, foldable devices, such as Huawei Mate Xs and Galaxy Fold 5G are rated at 69 and 90 hours respectively.

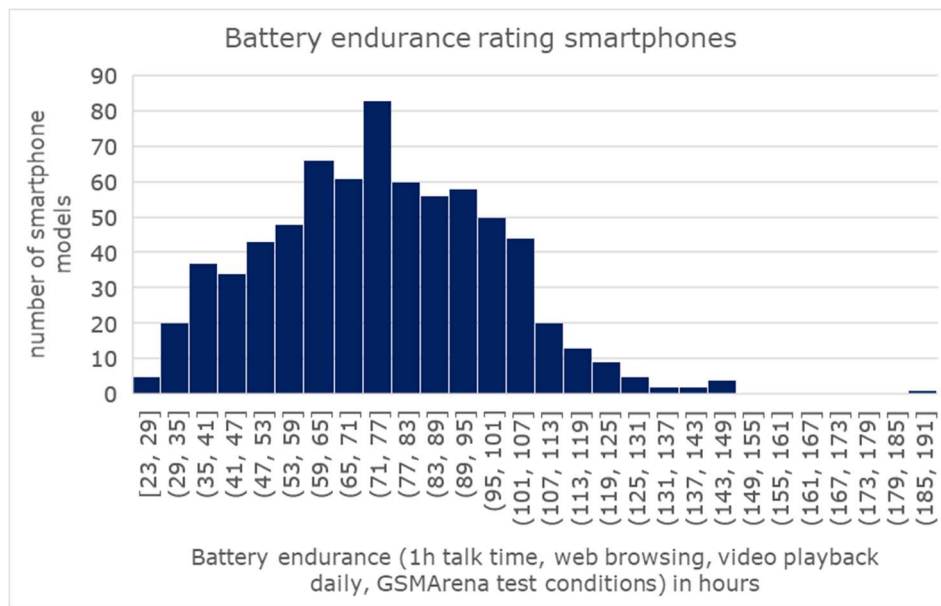

Figure 25 : Smartphones – Battery endurance testing results (GSMarena 2020)

There is a fair match between battery endurance and battery capacity – which is an expected correlation -, see Figure 26.

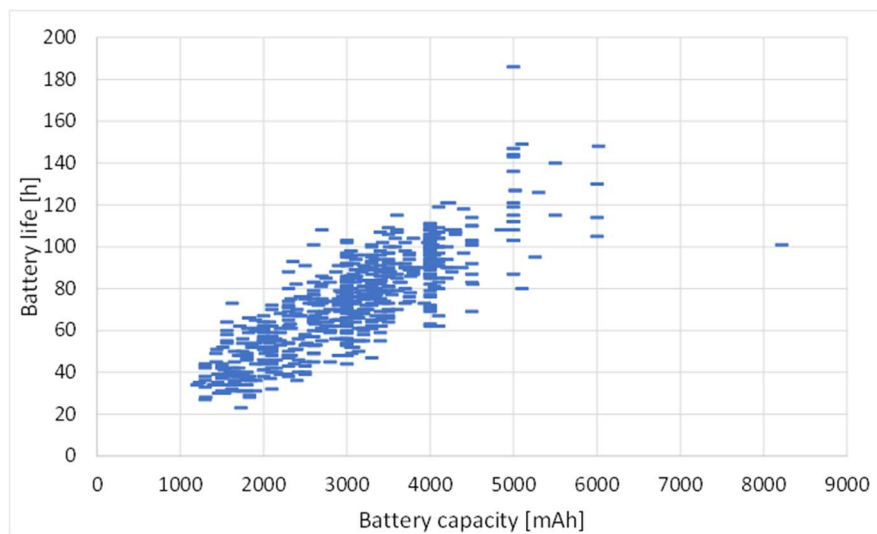

Figure 26 : Smartphones – Battery endurance correlated with battery capacity (GSMarena 2020)

Normalising the battery endurance by dividing endurance in hours by battery capacity in milliAmperehours shows the spread of battery endurance in the market without the effect, that a larger battery tends to result logically in a longer battery endurance. The resulting statistics are presented in Figure 27. Obviously there is a large variance, how efficiently smartphones run on a given energy budget under comparable conditions of use. There is a factor of three between the least and the most energy efficient devices, regardless of the display size. As a tendency, devices with a smaller display size reach better energy efficiency values.

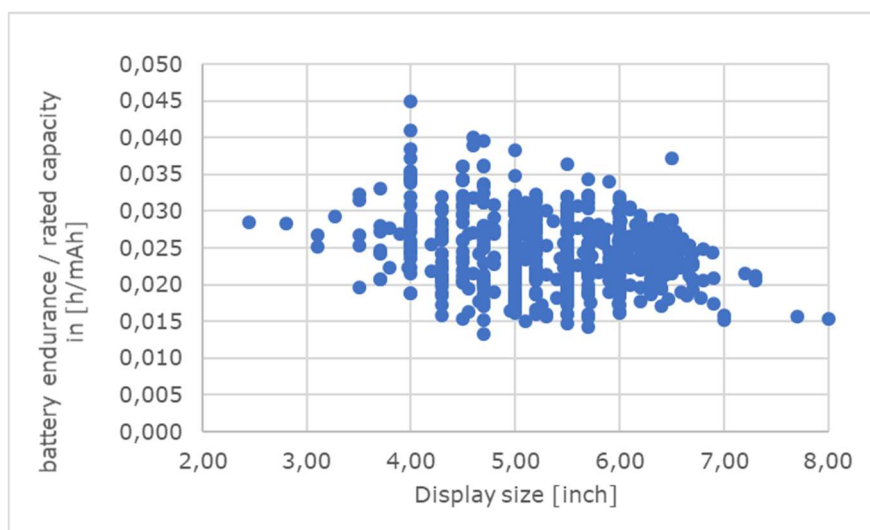

Figure 27 : Smartphones – Normalised battery endurance correlated with display size (GSMarena 2020)

The normalized test results are shown in the histogram in Figure 28: Under the given test conditions the spread of normalised battery endurance is between 0,014 and 0,045 h/mAh. The best rated phone is the (first generation) iPhone SE with 0,045 h/mAh. The best rated phone currently sold is the Realme 6i with 0,037 h/mAh. Current flagship devices, such as the Samsung S20 Ultra 5G and the iPhone 11 Pro Max are rated at 0,017 and 0,026 h/mAh respectively, foldable devices, such as Huawei Mate Xs and Galaxy Fold 5G are rated at 0,015 and 0,021 h/mAh respectively. These statistics are based on all devices tested by GSMarena, and most of these are not available in the market anymore, some have been available on regional markets only.

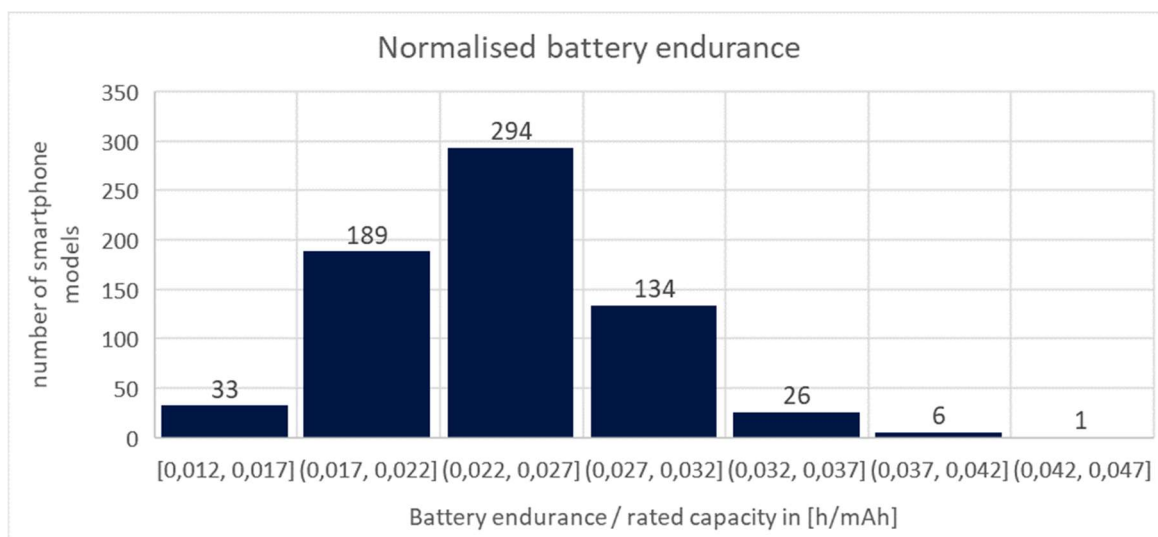

Figure 28 : Smartphones – Normalised battery endurance testing results (GSMarena 2020)

GSMarena data is considered a good benchmark, but the basic use scenario 1 hour talk time, 1 hour web browsing, 1 hour video playback daily, and inactivity the rest of the time leads to the conclusion, that the lowest rated devices have to be fully charged once a day and above-average smartphones every 3 to 5 days, which does

not fully correspond with the analysis in Task 3, which indicates a more frequent charging. Reasons might be running applications in the background or similar power draining issues, which are not considered in the GSMarena test protocol.

Battery endurance as such is not only crucial for user convenience and less so for energy consumption, but also for battery lifetime: The more often a battery has to be charged the shorter the overall lifetime will be, which might result in a shorter overall product lifetime.

The ICT Impact Study (Kemna et al. 2020) for the European Commission, published in July 2020, calculated the power consumption of smartphones as follows: "The energy consumption of smartphones has been determined by taking the endurance hours (based on a test by GSMarena) of the top eight most sold smartphones in Europe in 2019 and dividing them by the hours used per year. The theoretical number of charges has then been multiplied by two to provide data for a more realistic life scenario. The charges per year is multiplied by the battery capacity in Wh to give energy consumption per year. The energy consumption is then divided by an efficiency of 75 % to estimate the losses in the phone charger." It should be noted, that also the phone internal charging circuitry and the battery charging process as such is subject to some losses, so the actual energy consumption would be an estimated 10-20% higher: The charging efficiency (power drawn from the grid relative to the battery capacity) was measured to be 60 % for the Fairphone 3 in combination with two different chargers (Fairphone 3 power adapter and third party power adapter) (Proske et al. 2020b). One charging cycle (complete charge from 0% to 100% state of charge) was measured to consume 19.21 Wh. For all measurements, a fresh battery and an aged battery were used for at least three measurements each and results were averaged. Assuming a full charge/discharge cycle every day, this results in 7.01 kWh energy consumed annually for the Fairphone 3. Kemna et al. calculate with a rounded value of 4 kWh/a for smartphones.

Table 4 : Energy consumption for smartphones (Kemna et al. 2020)

Product	Battery capacity (mAh)	Battery capacity (Wh)	Endurance Rating (hour)	Battery capacity used per endurance hour	Theoretic charges per year	Assumed charges per year	Energy consumption kWh/year
Apple iPhone XR	2942	10.9	78	37.7	112.6	225.2	3.3
Samsung Galaxy A40	3100	11.5	73	42.5	120.3	240.7	3.7
Samsung Galaxy A50	4000	14.8	50	80	175.7	351.4	6.9
Apple iPhone 8	1821	6.7	66	27.6	133.1	266.2	2.4
Redmi Note 7	4000	14.8	108	37	81.3	162.7	3.2
Samsung Galaxy S10	3400	12.6	79	43	111.2	222.4	3.7
Samsung Galaxy A70	4500	16.7	103	43.7	85.3	170.6	3.8
Samsung Galaxy S10+	4100	15.2	91	45.1	96.5	193.1	3.9
Average							3.9

For comparison, Google publishes power consumption data for Pixel phones, Apple for the power supplies of iPhones (Table 5).

Table 5 : Use phase power consumption of exemplary mobile phones (Apple 2020a; Google 2020b)

Device	Power adapter efficiency	Power adapter no-load power	Standby power (battery maintenance mode)	Annual energy use estimate
Google Pixel 3a	82,5% at 5 V output 85,9% at 9 V output	0,02 W	0,55 W	6 kWh/a
Google Pixel 4	82,5% at 5 V output 85,9% at 9 V output	0,02 W	0,46 W	6 kWh/a
Google Pixel 4 XL	82,5% at 5 V output 85,9% at 9 V output	0,02 W	0,46 W	7 kWh/a
Google Pixel 4a (5G)	83,8% at 5 V output 87,3% at 9 V output	0,02 W	0,38 W	7 kWh/a
Google Pixel 5	82,5% at 5 V output 85,9% at 9 V output	0,02 W	0,30 W	8 kWh/a
iPhone 11 Pro	87,9%	0,03 W	-	-
iPhone 11 Pro Max	87,9%	0,03 W	-	-
iPhone 11	73,1%	0,012 W	-	-
iPhone Xr	73,1%	0,012 W	-	-
iPhone SE (2020)	73,1%	0,012 W	-	-

According to the data by Google, overall power consumption of a smartphone tends to be higher than calculated by Kemna et al.

Table 6 : ICT Electricity Consumption, EU27 (Kemna et al. 2020)

ICT category	TWh/year			
	2010	2015	2020	2025
Tablets / slates	0,1	2,58	1,87	1,34
Smartphones	0,45	1,58	1,65	1,75
Home / office fixed phones ⁹	4,15	4,42	4,48	4,13
<i>All other personal IT equipment</i>	<i>31,96</i>	<i>25,72</i>	<i>17,54</i>	<i>18,62</i>
<i>All other ICT</i>	<i>230</i>	<i>250</i>	<i>232</i>	<i>223</i>

Compared to the total ICT market the electricity consumption of smartphones and other products covered by this product group study is rather low. The ICT Impact Study (Kemna et al. 2020) calculated an EU27 electricity consumption of 8 TWh for

⁹ including cordless and wired landline phones, but modelling is based on cordless phone energy data

tablets / slates, smartphones and (any) fixed phone, compared to a total 232 TWh for all other ICT equipment (Table 6).

3.1.1.4. End of life phase

Data from various authors and regions of the world estimate that global collection rates for end-of-life mobile phones are below 50%, probably below 20% (Manhart et al. 2016). Collection rate in Europe for recycling, refurbishing and/or remanufacturing of smartphones was stated to be about 15% in Europe in 2012 (Ellen MacArthur Foundation 2012). Analyses in Germany indicate an even much lower collection rate of end-of-life devices, for mobile phones and smartphones actually in a negligible range close to 0%. As anecdotal evidence, one of the few large smelters in Europe processing e-waste Aurubis reports an input of roughly 50 t mobile phones annually (Wölbart 2016), which is less than 0,5 million devices – or roughly 0,3% of the mobile phones currently sold on the EU27 market¹⁰

Table 7 : Collection rates (Sander et al. 2019)

Device	Region	Year	Collection rate
Mobile phones	Germany	2012	1%
Smartphones	Germany	2012	1%
Tablet computers	Germany	2012	0%
Landline phones	Germany	2012	22%

There is close to no data available, if devices end up as household waste. One such data point is the following: 20% of young Norwegian adults throw small electronics in the waste bin (Watson et al. 2017).

An overall analysis of the end-of-life status quo of mobile phones in Belgium is depicted in Figure 29 (van der Voort 2013): Only 0,3% of all mobile phones were found to definitely reach a smelter, 20% end up as household waste, 65% are hibernating and might or might not be recycled later. Roughly 10% are collected, but sold outside the EU27, apparently for reuse at large.

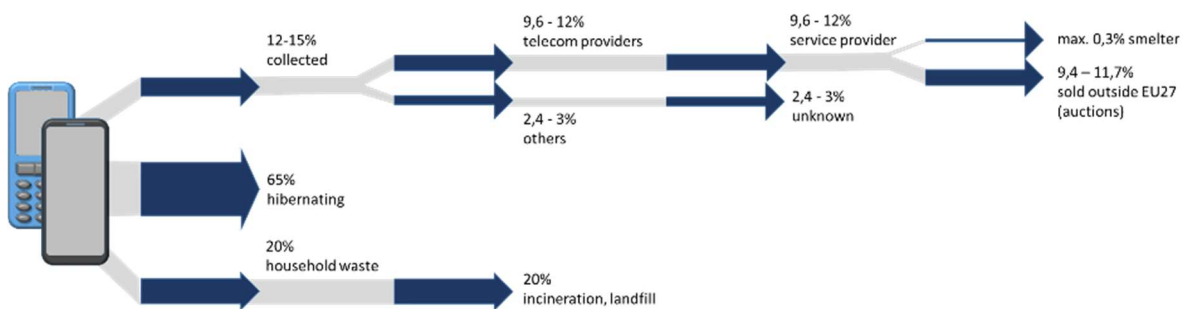

Figure 29 : Mobile phones – end of life routes in Belgium (van der Voort 2013)

Disposal with household waste clearly has negative environmental impacts due to the missed recovery of the residual value of products and to the fact that most household waste management systems are not designed for treating the various chemicals embedded in EEE (Cordella et al. 2020). Although state-of-the-art municipal waste incineration plants are equipped with bottom ash and slag processing to recover e.g.

¹⁰ note that Aurubis sources waste phones not only from within the EU27

precious metals, the applied processes include sieving and as such only recover larger parts, such as coins or rings, but not the miniature gold wires and coatings applied in small electronics.

Although there is a limited availability of coherent and reliable quantified data on the export pathways, there is a growing concern over exports and improper end-of-life management of mobile phones in countries without appropriate recycling infrastructure that poses environmental and health risks in these countries.

Regarding the end of life of chargers in particular the Impact Assessment Study for a common charger solution (Ipsos, Trinomics, Fraunhofer FOKUS, Economisti Associati 2019) asked in a user survey about disposal patterns for chargers (Figure 30). This data is particularly interesting in comparison to mobile phones as both a small e-waste. Hibernating devices is also a dominating phenomenon for chargers, but the stated share of 23% going to recycling facilities is much higher than what is observed for mobile phones. This data might suggest, that indeed factors like having spare data storage available and privacy issues are a barrier for mobile phones, which logically is not an issue for chargers.

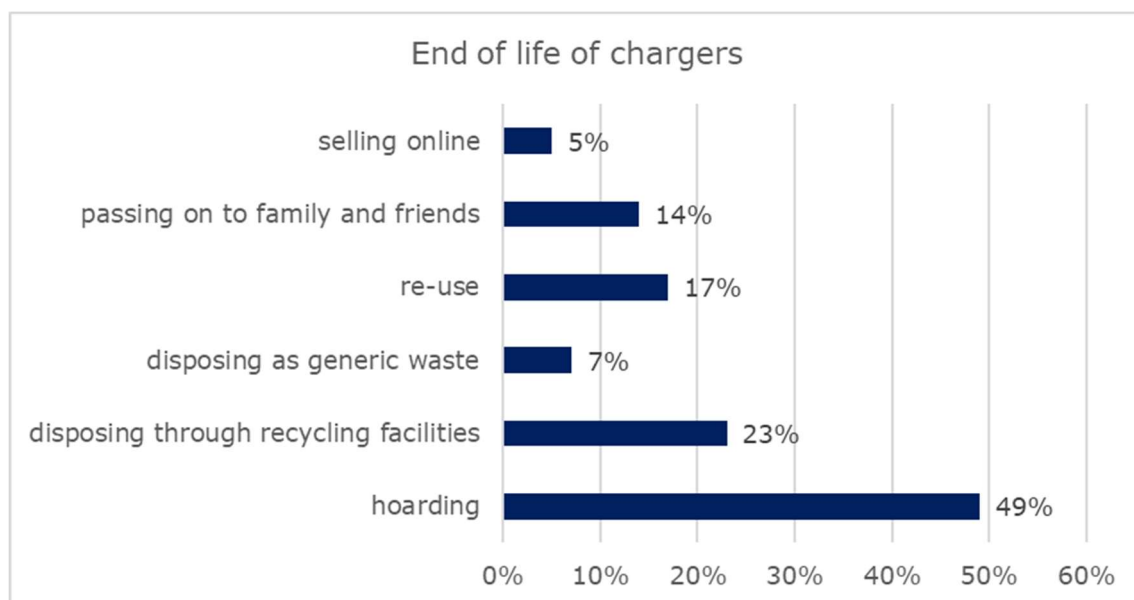

Figure 30: End of life of chargers (Ipsos, Trinomics, Fraunhofer FOKUS, Economisti Associati 2019)

3.1.2. Tablets

3.1.2.1. Technical characteristics

Key technical criteria for tablet computers are listed in Table 8. The table compares the analysis of the Computer Review study (Maya-Drysdale et al. 2017b) made in 2017 with most recent data from retail platforms.

CPU performance has increased to 4 cores – and up to 10-core CPUs found in the tablet market -, and also RAM tends to be typically 2 to 4 GB currently. Integrated memory storage are solid state disks, which are actually memory chips assembled directly on the mainboard. The storage capacity still covers the full range from 16 GB to 128 GB and for high-end devices up to 1 TB are common nowadays. The Graphics Processing Unit (GPU) in tablets hardly ever came as a separate chip or even a distinct

graphics card, but is integrated in the CPU – which does not necessarily mean low graphics power¹¹. The rated output power of power supply units now allows for fast charging, with typically 18 – 25 VA output, but usually also supporting slower charging rates. Display sizes increased and so did the display resolution in the last few years.

Popular storage capacities are 16, 32, 64, and 128 GB. Some flagship tablets provide up to 1 TB flash memory capacity. System memory has slightly increased in recent years and both, 2 and 4 GB RAM are most common (Table 8).

Table 8: Tablet computer average configuration

Technical parameter	Typical values		
	2017	2020	
		typical (min-max)	source
CPU cores	2	4 (1-10)	idealo
base CPU speed per core, GHz	1,3 GHz	1,8 GHz (1,1 – 2,8 GHz)	Energy Star
RAM	2 GB	2/4 GB (1 – 16 GB)	idealo
hard disk type	SSD	SSD	
storage drives count	1	1	
total storage capacity	16/32/128 GB	16/32/64/128 GB (8 GB – 1 TB)	idealo
GPU type	None	CPU integrated	
PSU rated output	10 VA	18 - 25 VA	
EPS average efficiency	88%		
integrated display size (sq in)	28-73 in ²	10,1 and 12,3 inch diagonal	
integrated display resolution	2,07 MP	3,6 MP (0,6 – 5,6 MP)	idealo

There are major differences in battery capacity of tablet computers, ranging from below 1.000 mAh to the aforementioned 12.000 mAh (see Figure 31). Based on more than 660 individual tablet configurations¹² the average battery capacity of current tablets is roughly 5.900 mAh.

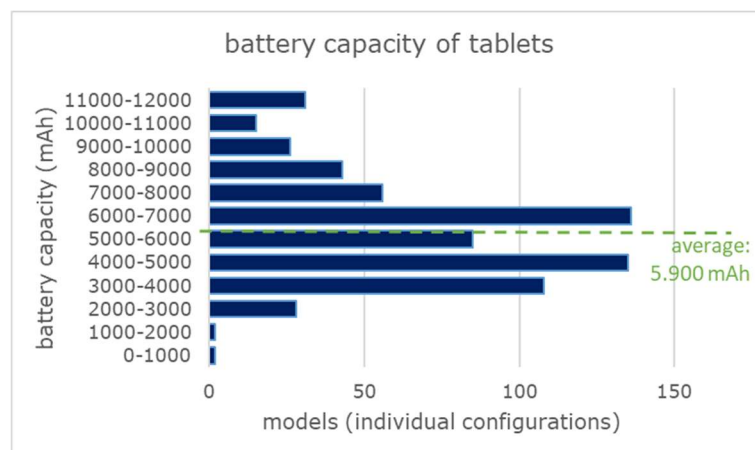

Figure 31 : Tablet computers, battery capacity and number of models (2020)

¹¹

¹² <https://versus.com/en/tablet>, accessed August 11, 2020

In the framework of the German research project MoDeSt a data set of 9,600 smartphone models and their technical specification was analysed (Proske et al. 2020a). The data base included also 636 data sets for tablets (criterion for tablets: > 7"), which are analysed for this study. As for the smartphones, this data does not take into account market shares and sales figures, but is analysed per model.

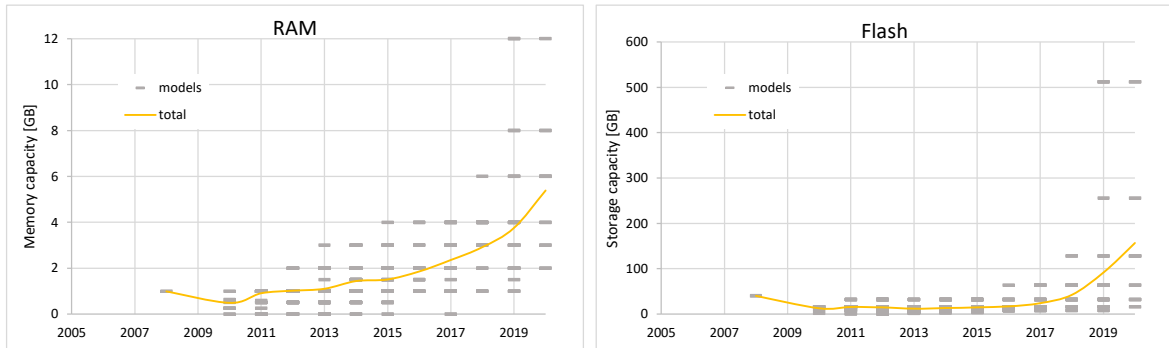

Figure 32: Development of the amount of RAM and internal storage employed in tablets between 2008 and 2020

RAM and storage increased significantly since the introduction of tablets to the market with near exponential growth for the maximum values (similar as for smartphones).

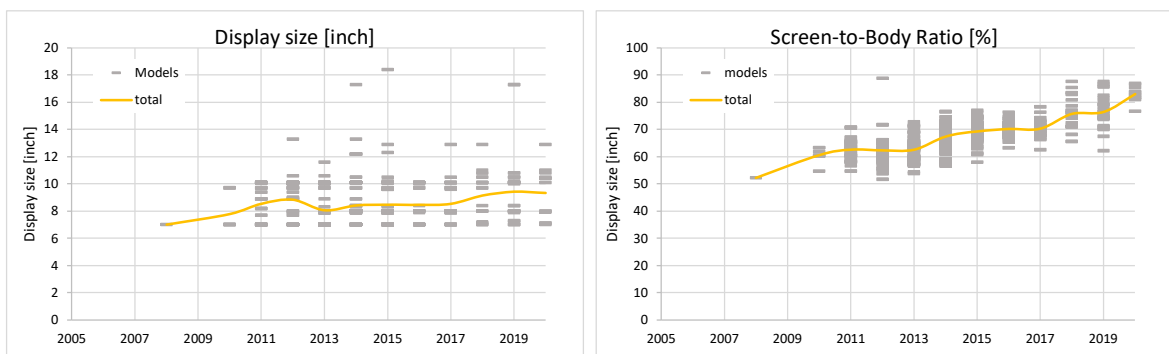

Figure 33: Development of screen size and screen-to-body ratio of tablets between 2008 and 2020

Average display size increased from below 8 to over 9 inch with the screen-to-body ration increasing from 60% to 80% over the same time (Figure 33).

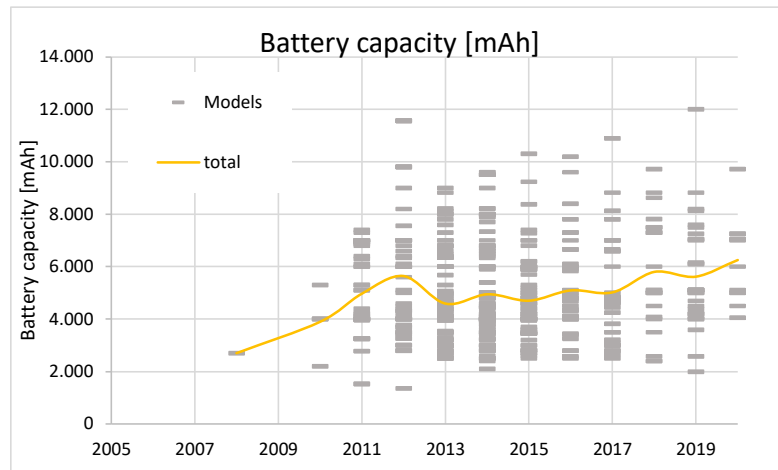

Figure 34: Development of battery capacity of tablets between 2008 and 2020

Battery capacity increased slightly with a wide spread range of battery capacities and no clear trend (Figure 34).

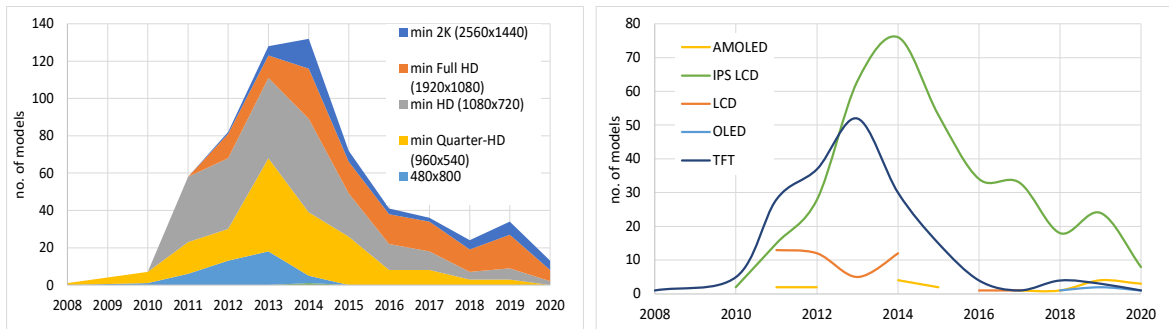

Figure 35: display type and resolution of tablets between 2008 and 2020

Since 2013, the majority of display has at least HD resolutions, since 2015 at least full HD. The mostly widely installed display technology is IPS LCD (Figure 35).

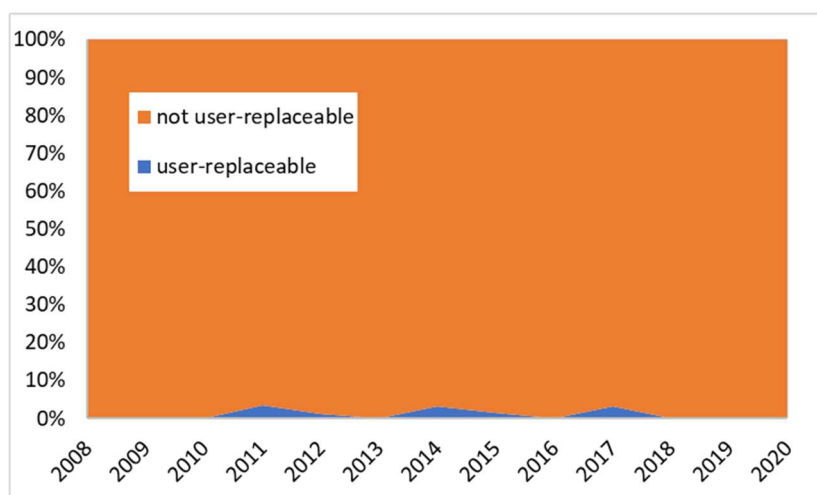

Figure 36: user-replaceability of batteries in tablets between 2008 and 2020

As shown in Figure 36, since the introduction of tablets, the majority of models had built-in batteries and user-replaceable batteries are a rare niche.

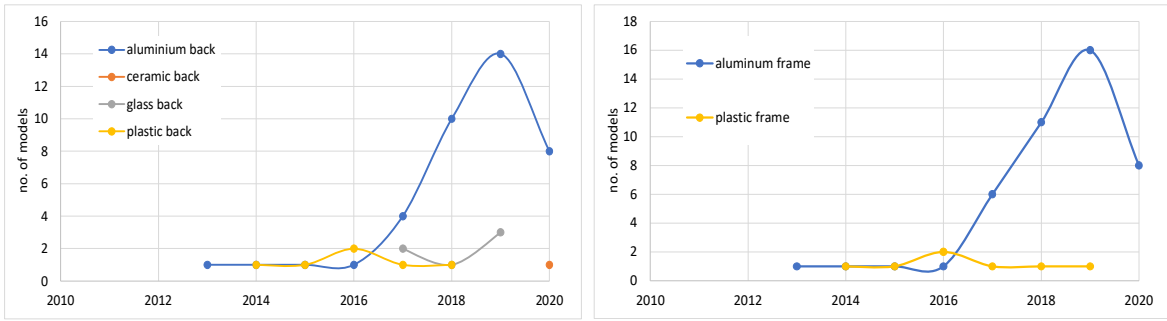

Figure 37: backside and frame material of tablets between 2013 and 2020

The majority of tablets has aluminium frames and back plates. Glass backs exist but are not as common as for smartphones (Figure 37).

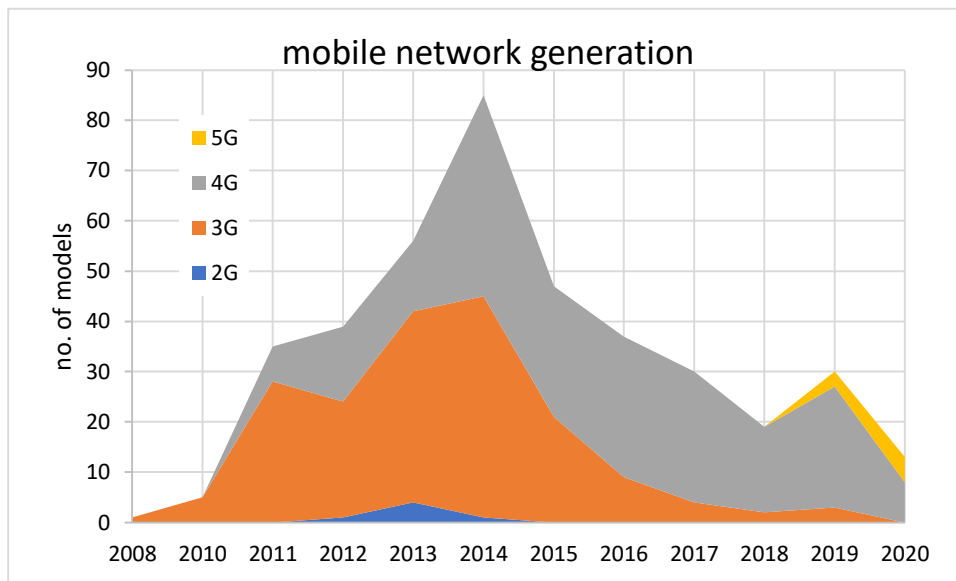

Figure 38: Mobile network generation technology in tablets between 2008 and 2020

Since 2016, the majority of tablets with the ability to connect to the mobile network is 4G capable.

3.1.2.2. Composition

In 2013, being the most comprehensive analysis on tablet computers to date, Fraunhofer IZM disassembled a total of 20 different tablet computers (Schischke et al. 2014). The selection of the units, which are all slate designs, no detachables, was based on several criteria, such as the market relevance (sales rankings, reviews, novelty), the price category (EUR 120-600), the display size (diagonal 7-10 inches), and performance (CPU, RAM, storage, battery, operation system). The composition of the different tablets were retrieved during disassembly tests.

Table 9: Tablets, composition (2013)

Material group	All tablets (average)	Tablets type: Al-housing (average)	Tablets type: Plastic housing (average)
Aluminium	41.5	103.7	0.0
Steel sheet	3.9	0.0	6.6
Magnesium	14.8	4.2	21.8
Plastics (unmarked)	4.0	0.0	6.7
ABS	1.0	2.5	0.0
Polycarbonate	13.1	0.0	21.8
Polycarbonate + GF	9.0	0.0	15.0
ABS+PC	24.6	21.9	26.4
Display panel	226.8	226.8	226.7
Printed circuit board/auxiliary boards; with electromagnetic interference (EMI) shielding	44.0	52.0	38.6
Speaker	3.3	3.4	3.2
Battery	124.6	150.1	107.6
Screws, small cables and other miscellaneous components	18.1	18.5	17.9
Tablet: average weight	528.7	583.1	492.3

Table 9 shows the average composition derived from the disassembly of 20 tablets, as well as the distinction of tablets with Al-housing and of tablets with plastic housing. This distinction in the market is still relevant: Either tablets come with a metal shell providing the intended stability, or with a plastic housing and then typically a kind of metal mid-frame for stability.

Another split of material data on tablets is provided in Table 3, p. 34 (Manhart et al. 2016), side-by-side with the data for smartphones.

Typical metals used in tablets are largely the same as in smartphones as both products share similar functionalities and are both space constraint.

To illustrate the use of gallium in tablets Figure 39 depicts the radio frequency area of the iPad mini (2013 model) mainboard, overlaid with analytical results, where Ga is found (disassembly: Fraunhofer IZM; μ RFA analytics: Fraunhofer IWKS). In 15 different IC packages a total of 19 gallium containing semiconductors is found. Total area of gallium-based semiconductor dies in the iPad mini is approximately 14 mm², which roughly equals 2 mg Ga scattered over various semiconductor packages.

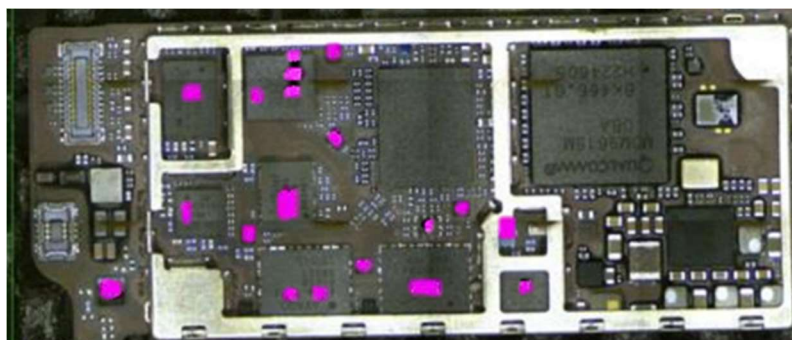

Figure 39: Radio-frequency part of tablet mainboard, Ga marked as found by μ RFA

The content of materials in tablets with a more granular split than the 2013 disassembly study cited above is provided in Table 10. This data includes among

others the content of precious metals and rare earth elements and some other critical raw materials.

Table 10 : Material content tablets

Material	Main application	Content per tablet (Manhart et al. 2016)	Content per tablet (Sander et al. 2019)
Aluminium	case	56.59 g	
Copper	wires, alloys, electromagnetic shielding, printed circuit board, speakers, vibration alarm, battery	40.79 g	
Plastics	case, antenna substrate, module housings, connector housings	26.49 g	
Magnesium	mid-frame	13.57 g	
Cobalt	lithium-ion battery	15.55 g	n.a.
Tin	solder paste	3.19 g	5.273 g
Iron (steel)	case, shielding, module housings	2.44 g	
Tungsten	vibration alarm	0.27 g	
Silver	solder, printed circuit board	0.31 g	0.0264 g
Neodymium	magnets of speakers, vibration alarm, camera mechanics, cover fixation	0.60 g	0.347 g
Gold	electronic components, printed circuit board finish, connectors / contact pads	0.03 g	0.131 g
Tantalum	capacitors	0.04 g	0.0237 g
Palladium	electronic components, printed circuit board finish	0.01 g	n.a.
Praseodymium	magnets of speakers, vibration alarm, cover fixation	0.15 g	
Indium	display	0.02 g	0.0286 g
Yttrium	LED-backlights	0.002 g	0.0019 g
Gallium	LED-backlights, RF components	0.002 g	0.0004 g
Gadolinium	LED-backlights	0.001 g	
Europium	LED-backlights	0.0003 g	
Cerium	LED-backlights	0.0001 g	
Others	ceramics, semiconductors...	204.43 g	
	glass	66,53 g	
		431 g	

With growing display sizes of tablet computers the average weight of the devices increased as well since 2013. Figure 40 correlates the weight of best-selling devices in mid 2020¹³ with screen sizes. The most light-weight tablet according to this data is the Android Alldocube iPlay 7T tablet with a screen size of 7" and a weight of only 224 g –

¹³ Based on <https://tabletmonkeys.com/tablet-comparison/>, accessed August 10, 2020

but also with a rather low battery capacity of 2.800 mAh. The other end of the weight spectrum is represented by the Samsung Galaxy View 2 with the largest display size of 17,3" and a weight of 2.231 gram – and a 12.000 mAh battery.

For a "typical" tablet in the 10,1" segment statistical data suggests a weight of 524 gram, for a 12,3" tablet a plausible weight is 734 gram.

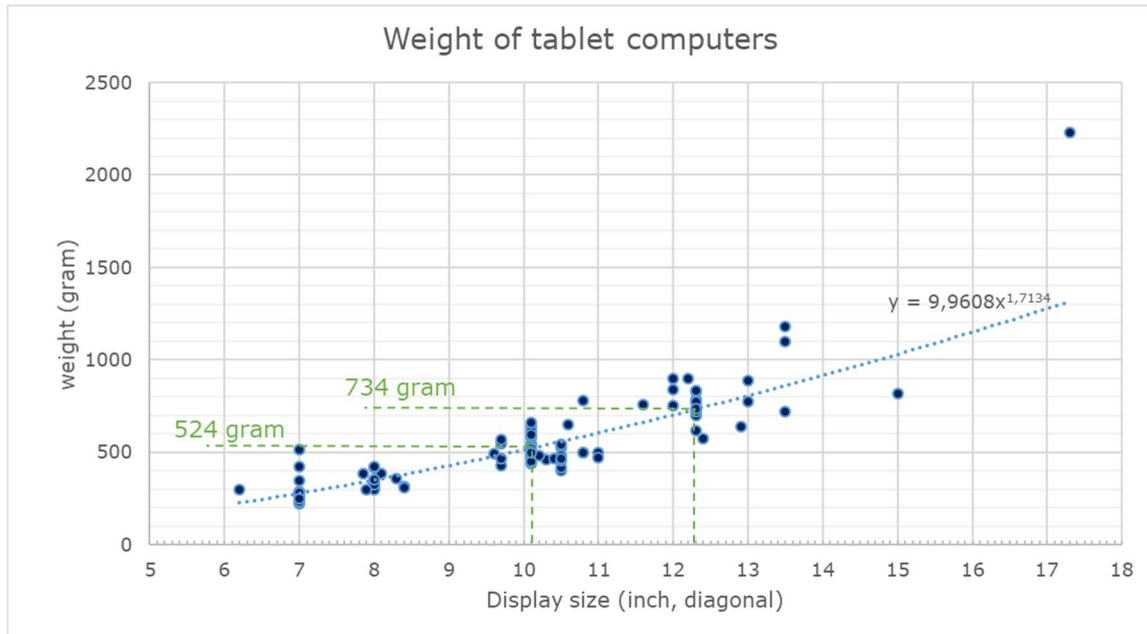

Figure 40 : Tablet computers, weight correlated with display sizes (2020)

Material composition data as published by Huawei for a range of tablet models is depicted in Figure 41.

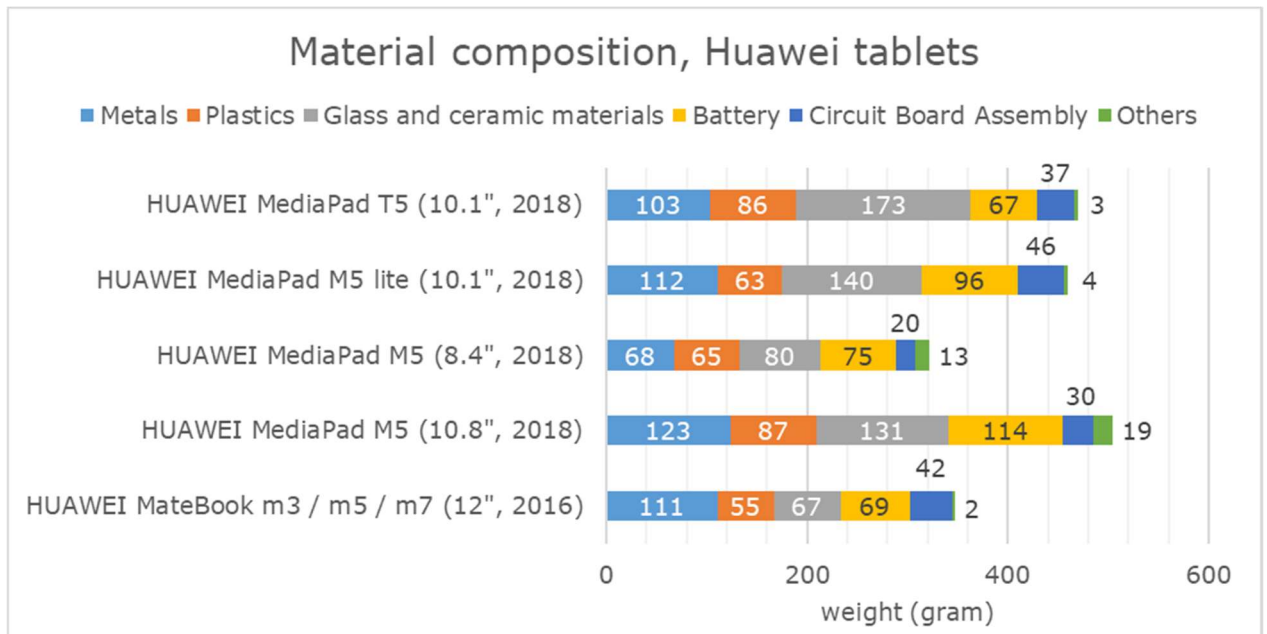

Figure 41 : Tablet computers, material composition, Huawei (2016-2018)

Material composition data published by Google for the Google Pixel Slate¹⁴ (12.3 inches display size) are listed below.

Table 11 : Material composition Google Pixel Slate

Material / Component	Weight
Aluminum	209 g
Steel	28 g
Other metals	15 g
Plastics	25 g
Display assembly	208 g
Battery	181 g
Electronics	63 g
Other	2 g
Total weight	731 g

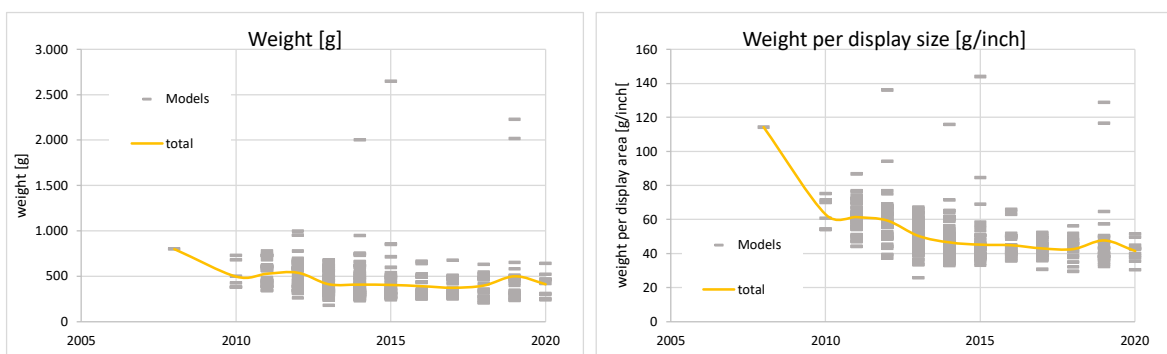

Figure 42: weight of tablets between 2008 and 2020

The absolute weight of the tablets is more or less stable with only a small reduction in weight per display size.

3.1.2.3. Use phase power consumption

Power consumption of tablets is mainly related to similar components as with smartphones:

- CPU
- Video / image / graphics processing
- RF modems / interfaces (if implemented): Bluetooth, WiFi, 3G / 4G / 5G, and GPS
- Display / backlight

The relevant modes are:

- Active battery charge
- Maintenance or trickle-charge (tablet is connected to the external power supply, but battery is fully charged)
- Power adapter no-load (external power supply is plugged in, but disconnected from tablet)

¹⁴ https://mannequin.storage.googleapis.com/sustainability/reports-2018/Sustainability_PrintReport_PixelSlate.pdf?hl=en-US

The power adapter no-load mode is already fully covered by the external power supply regulation (see Task 1), and referenced and considered here only for completeness. To align power measurements of tablets with those of other computer products, a frequent distinction of modes is

- Off mode Power (W)
- Sleep mode power (W)
- Short idle mode power (W)
- Long idle mode power (W)

These are also the modes measured for Energy Star requirements.

The 2017 Review Study for Computers identified tablet power consumption as listed below in the table below (Maya-Drysdale et al. 2017a). A distinction is made of tablet categories 0 – I3 as made by Energy Star requirements.

Table 12 : Average power consumption data for Slate/Tablet computers, 2017 data

Parameter	Overall	Category 0	Category I1	Category I2	Category I3
Number of products in each category	66	1	35	19	11
Measured power consumption - averages for each category					
Off mode Power (W)	0.420	0.30	0.443	0.289	0.582
Sleep mode power (W)	0.797	0.40	0.623	1.14	0.800
Short idle mode power (W)	5.742	6.90	4.93	6.97	6.11
Long idle mode power (W)	5.50	3.10	1.71	2.21	2.34
Other parameters - averages for each category					
Energy Star TEC value (kWh)	17.6	11.9	16.7	16.8	21.6
External power supply average efficiency (%)	85.4	-	85.9	83.9	86.0
Power supply unit rated power (W)	31.25	-	35.9	36.1	10.8
External power supply Efficiency, 10% load (%)	85.8	-	86.0	83.8	89.0

Exemplary power consumption values of individual tablet computers is provided in Table 13.

Table 13 : Use phase power consumption of exemplary tablets

Device	Power adapter efficiency	Power adapter no-load power	Off mode power	Sleep mode power	Long idle mode - display of	Short idle mode - display on	Annual energy use estimate	Reference / Display size
Google Pixel Slate	82,5% at 5 V output 90,0% at 20 V output	0,03 W	0,34 W	0,69 W	2,53 W	5,57 W	27 kWh/a	Google ¹⁵ / 12.3"
Lenovo Tab P10	82,57%	0,051 W	0,23 W	0,26 W	2,12 W	2,12 W	8,73 kWh/a	Lenovo ¹⁶ / 10.3"
Lenovo Tab M10 HD (2nd Gen)	81,93%	0,0326 W	0,15 W	0,21 W	0,21 W	2,2 W	6,98 kWh/a	Lenovo ¹⁷ /10.1"
Lenovo Tab M10 FHD Plus 2nd Gen	81,93%	0,0326 W	0,0876 W	0,2148 W	0,2148 W	5,28 W	14,94 kWh/a	Lenovo ¹⁸ /10.3"
Lenovo Tab M8 HD for Business	81,82%	0,0326 W	0,17 W	0,32 W	0,32 W	3,46 W	8,84 kWh/a	Lenovo ¹⁹ /8"
Lenovo TAB M7	74,6%	0,04 W	0,2328 W	0,3924 W	0,3924 W	2,6484 W	9,47 kWh/a	Lenovo ²⁰ /7"
Lenovo Tab E10	82,1%	0,051 W	0,051 W	0,17 W	2,43 W	2,43 W	9,17 kWh/a	Lenovo ²¹ /10.1"
MEDION LIFETAB E10530	81,35%	0,062W						Medion ²² /10.1"

The web portal Notebookcheck reviews extensively the performance of tablets, including power measurements. These measurements are undertaken when the device is connected to the grid, and the battery is fully charged:

- Off: smartphone connected, but switched off
- Standby: smartphone connected, but switched off
- Idle average: smartphone is idle, maximum brightness, additional modules off
- Load average: smartphone runs with maximum brightness, all modules on, Android devices tested with the app "Stability Test" Classic, iOS and Windows 10 mobile devices tested with app Asphalt 8

¹⁵ https://mannequin.storage.googleapis.com/sustainability/reports-2018/Sustainability_PrintReport_PixelSlate.pdf?hl=en-US

¹⁶ https://www.lenovo.com/us/en/social_responsibility/Lenovo_Tab_P10.pdf

¹⁷ <https://static.lenovo.com/ww/docs/regulatory/eco-declaration/eco-lenovo-tab-m10-hd-2nd.pdf>

¹⁸ <https://static.lenovo.com/ww/docs/regulatory/eco-declaration/eco-tab-m10-fhd-plus-2nd.pdf>

¹⁹ <https://static.lenovo.com/ww/docs/regulatory/eco-declaration/eco-lenovo-tab-m8-hd-business.pdf>

²⁰ <https://static.lenovo.com/ww/docs/regulatory/Lenovo-TAB-M7.pdf>

²¹ https://static.lenovo.com/ww/docs/regulatory/Lenovo_Tab_E10_Update.pdf

²² [http://download2.medion.com/downloads/anleitungen/bda\(ex\)_lifetab_e10530_en.pdf](http://download2.medion.com/downloads/anleitungen/bda(ex)_lifetab_e10530_en.pdf)

Measured power consumption values for 337 tablets is depicted in Figure 43. There are huge differences in these power consumption values among the various models, which is partly correlated with the display size, but also other performance aspects as some of the tablets covered in this statistics serve advanced graphics and computing purposes. Under average load most of the tablets consume 5 – 15 W.

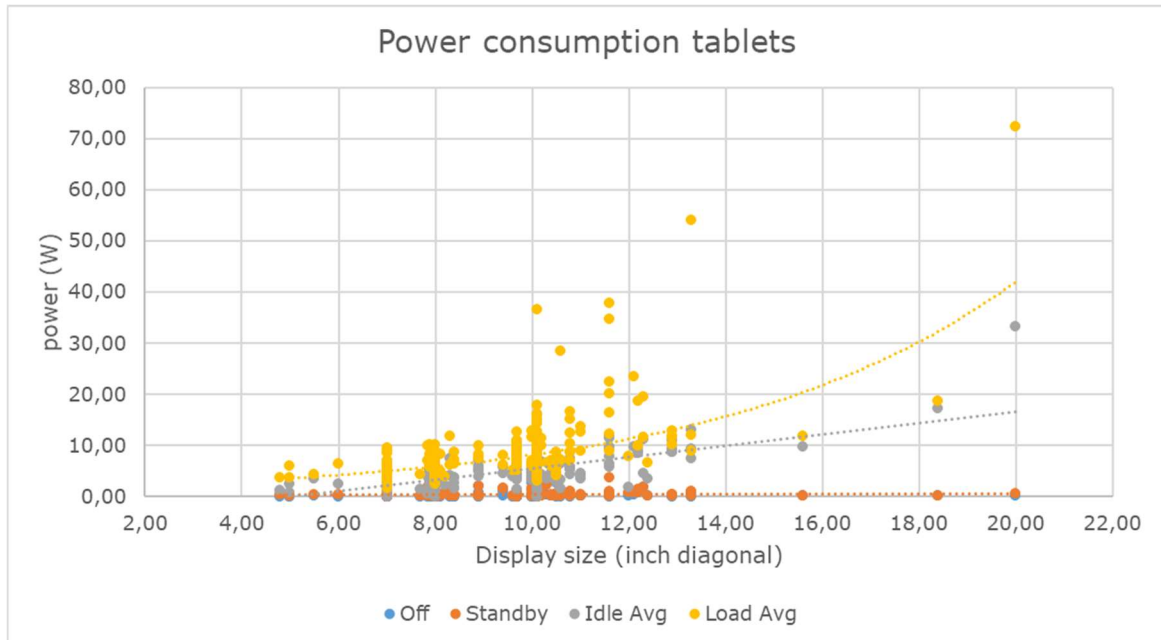

Figure 43 : Tablets – Power consumption in various modes (Notebookcheck 2020)

The ICT Impact Study (Kemna et al. 2020) for the European Commission, published in July 2020, modelled the power consumption of tablets based on updated non-published internal modelling files by Viegand Maagøe that supports the computer regulation. Stated power average annual power consumption goes down since 2010 and is predicted to decrease further down to forecasted 10 kWh per year and device total energy consumption (Table 14).

Table 14 : Energy efficiency metric for tablets (Kemna et al. 2020)

Product type	TEC (kWh/year/device)					
	2005	2010	2015	2020	2025	2030
Tablet/slate average total	-	30.9	20.8	18.6	10	10

3.1.2.4. End of life phase

End of life of tablet computers is assumed to be similar to mobile phones. Probably even less devices reach proper recycling: As the analysis in Task 2 indicates, many of the tablets ever sold on the European market are still in (limited) use. The problem of hoarding devices after use life can be assumed to be similar to smartphones.

For tablets, just as for smartphones, the WEEE directive requires a separation of the battery first.

After battery removal, three possible pre-processing approaches are relevant according to the JRC study "Analysis of material efficiency aspects of personal computers product group" (Tecchio et al. 2018), depending on the facility and taking into account economic considerations.

- Scenario 1: shredding of the whole device via cross-flow shredder.
- Scenario 2: deep-level manual dismantling of the subassemblies (such as aluminium or plastic housing, mainboard, LCD, magnesium frame if present), using predominantly screw drivers (battery powered and hydraulic).
- Scenario 3: direct treatment in copper smelter after removal of the battery.

The representativeness of the second scenario is limited, since the likelihood that the labour cost for manual dismantling is not covered by the value of material disassembled for recycling is very high. For deep-level manual dismantling, the following materials and components were identified by the 2018 JRC study as potentially relevant:

- **Plastics:** In general, plastics can be separated according to their colour: white (including light grey), black, and mixed colours. White plastics have a significantly higher value compared to black plastics. Black plastics contain carbon black, which complicates the proper identification and subsequent separation.
- **Aluminium:** Aluminium housing is of high interest for material recycling and it can justify a slightly increased disassembly effort. Magnets (or other metal parts such as copper) attached to the aluminium housing can reduce the recovery value via mechanical processing.
- **Magnesium:** Magnesium frames are frequently found in tablets with plastic back-covers. Currently, magnesium frames are not dismantled into separate fractions, but are rather processed together with the aluminium fraction, if being separated at all. For high-quality magnesium recycling, it is necessary to achieve a high purity magnesium fraction, which is difficult via mechanical separation due to the similar physical properties in terms of melting points of Al and Mg.
- **Display panels:** Display panels contain minuscule quantities of indium and REE as well as gold in minor amounts, which is used for interconnects and connectors of light-emitting diodes (LEDs) and for controlling ICs. However, except for the gold, recycling systems are not yet adjusted to recover them efficiently. The time needed to separate the display panel from the rest of the device is critical. According to recyclers, the display panel would be separated manually under the condition that it is easily accessed and removed. If the front glass is not fused to the rest of the LCD unit, it would be separated. However, as tablets do not contain mercury containing backlights, separation of the display panels has a lower priority compared to e.g. the pre-processing of display panels from older notebooks and electronic displays.
- **Printed Circuit Boards:** Tablet mainboards are considered high-grade. After tablet opening, the PCB can be easily removed and sorted. No removal of electromagnetic interference (EMI) shields from PCBs is provided for as the amount of material is not worth the effort.

End of life recycling scenarios have also been analysed by Arduin et al. (2017) and are summarised in Table 15. Based on our insights, we tend to consider a hybrid scenario of the conservative and pessimistic scenario to be the most realistic one: Extracting the battery followed by shredding the remaining parts mixed with small equipment, metal recycling and PCB recycling in a smelter, i.e. roughly corresponding to Tecchio's scenario 3 further above.

Table 15 : Tablets, EoL scenarios (Arduin et al. 2017)

Components	Optimistic scenario	Conservative scenario	Pessimistic scenario
LCD	Recycling of the glass and landfill of LCD module	Landfill	
Aluminum alloy	Shredding, sorting and recycling	Shredding, sorting and recycling	Tablet shredded mixed with small equipment followed by sorting and recycling of classical metals (iron, copper and aluminum)
Battery Lithium-ion	Manual sorting and recycling	Manual sorting and recycling	
Printed Circuit Boards (PCB)	Manual sorting, recycling of precious metals and plastic incineration with energy recovery	Manual sorting, recycling of precious metals and plastic incineration with energy recovery	
Other metals	Shredding, sorting and recycling	Shredding, sorting and recycling	
Plastics	Shredding, sorting and recycling	Shredding, sorting and recycling	
Sorting and recycling losses	Incineration with energy recovery	Landfill	

From a life cycle assessment perspective the analysis by Arduin et al. indicates a significant environmental benefit of both, the optimistic and conservative scenario in comparison to the pessimistic scenario. Arduin et al. argue that this “reinforces the benefits of improving WEEE recycling in order to reduce the destination of e-waste to landfills.”

3.1.3. Cordless phones

Typical features of cordless phones are an integrated answering machine, emergency function, Bluetooth connectivity, contacts registry, phone call depending ringtone, anonymous calling, call blocking service, night mode, baby phone function, sending and receiving text messages.

For the German market – which is highly relevant for cordless phones – Stiftung Warentest tested DECT phones in 2018 and before that in 2015. Currently²³ 40 tested DECT phones are still available on the market. As Stiftung Warentest typically tests best-selling models, these figures can be considered representative for the German market and a good proxy for the EU market.

In all cases the base station (or router) with which the handsets have been tested allow for adjustment of the transmission power (Figure 44). The base station (and the handset) also support a low radiation feature (EcoPlus) in all but one case. These power saving features thus can be considered already standard on the market, but see the adverse effect on handset power consumption further below.

²³ as of August 2020

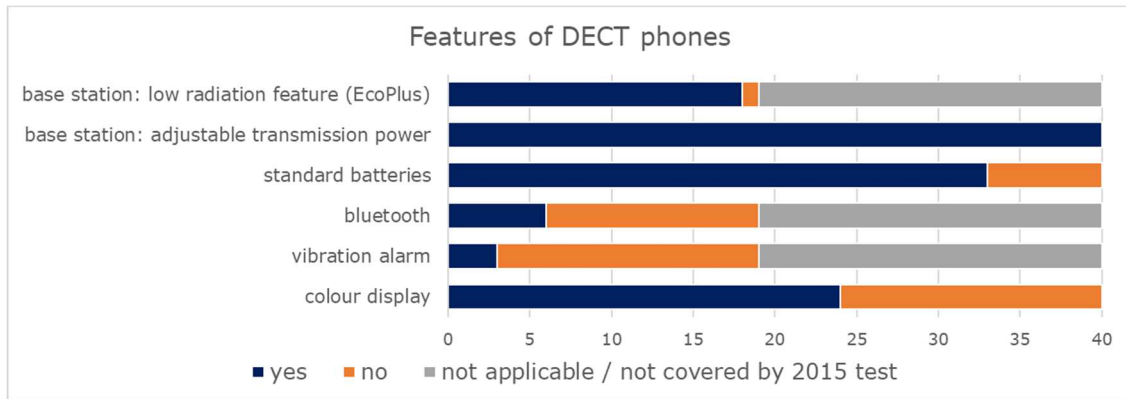

Figure 44 : Features DECT phones (data by Stiftung Warentest, compilation by Fraunhofer IZM)

Bluetooth and vibration alarm are less frequently found functionalities of DECT phones. More than half of the tested DECT phones come with a colour display.

33 out of the 40 tested DECT phones available on the German market feature standard batteries. The batteries used with DECT phones are typically two NiMH AAA batteries, 750 mAh being a typical capacity per battery.

The weight of DECT phones (handsets) ranges from 105 to 161 g, with an average of 129 g (Figure 45).

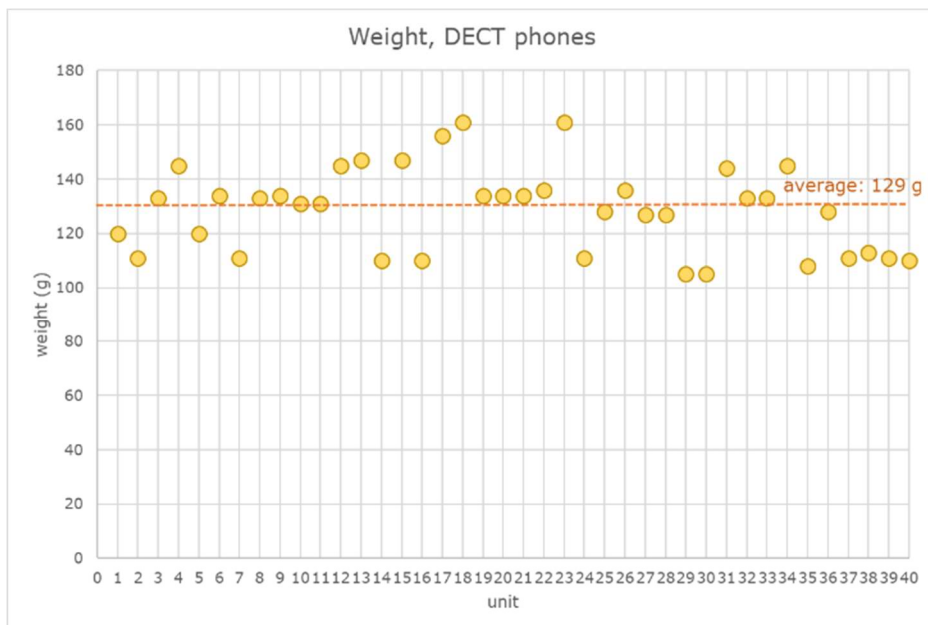

Figure 45 : Weight, DECT phones (data by Stiftung Warentest, compilation by Fraunhofer IZM)

3.1.3.1. Composition

Some precious metals and critical raw materials of landline phones as stated by Sander et al. are referenced in Table 16. The value stated for cobalt is rather non-typically as there are usually no Li-ion batteries in cordless phones but NiMH batteries. Furthermore the table lists other bulk materials, which are potentially found in cordless phones and their main application.

Table 16 : Material content landline phones

Material	Main application	Content per landline phone (Sander et al. 2019)
Aluminium	case	
Copper	wires, alloys, electromagnetic shielding, printed circuit board, speakers, vibration alarm, battery	
Plastics	case, antenna substrate, module housings, connector housings	
Magnesium	mid-frame	
Cobalt	lithium-ion battery	0.0226-0.7 g
Tin	solder paste	4.52 g
Iron (steel)	case, shielding, module housings	
Tungsten	vibration alarm	
Silver	solder, printed circuit board	0.294-0.305 g
Neodymium	magnets of speakers, vibration alarm, camera mechanics, cover fixation	0.167 g
Gold	electronic components, printed circuit board finish, connectors / contact pads	0.0038-0.0271 g
Tantalum	capacitors	0.0005 g
Palladium	electronic components, printed circuit board finish	0.0008-0.0224 g
Praseodymium	magnets of speakers, vibration alarm, cover fixation	
Indium	display	0.0149 g
Yttrium	LED-backlights	0.0029 g
Gallium	LED-backlights, RF components	0.043 g
Gadolinium	LED-backlights	
Europium	LED-backlights	
Cerium	LED-backlights	
Others	ceramics, semiconductors... glass	

A typical design of a cordless phone is shown in the following teardown of a Gigaset A415 A. The overall structure is similar to those of feature phones, see 3.1.1.2: On the backside there is a removable battery cover. Batteries are AAA-size NiMH cells (Figure 46).



Figure 46 : Cordless phone handset teardown – frontside, batteries, battery cover

The key pad is flexible silicone rubber. Numbers, characters and symbols are printed on coated areas of the rubber part. On the back side of the key pad small metal plates upon button pressure are pressed onto the mainboard, where structures apparently made of graphite act as conductive counterparts. The display unit is attached to the mainboard, and the loudspeaker is located directly above the display. Front and back side cover are made of plastics, ABS being a typical polymer for these parts. The front side is partly coated and printed.



Figure 47 : Cordless phone handset teardown – frontside cover, key pad, display and mainboard, backside cover

The mainboard stretches over the full size of the device as it acts as carrier for the key pad contacts, display, loudspeaker and battery clamps, and thus providing also mechanical stability to the overall device.



Figure 48 : Cordless phone handset teardown – frontside cover inside view, key pad backside, mainboard reverse side, display unit backside view, loudspeaker, backside cover

On the mainboard there is a limited number of components, compared to smartphones. In the design shown in Figure 49 12 LEDs are mounted over PCB holes and illuminate the keyboard on the opposite side of this PCB. The printed circuit board is a double-sided SMD board, with apparently a chemical tin surface finish. The main chip is a digital CMOS ICs with integrated radio transceivers including RF Power Amplifier and baseband processors for DECT, here in a 12x12 mm QFN80 package (approx.. 400 mg). A quartz crystal is located in proximity to this IC (100 mg) and a battery controller chip (SOIC-8 package, 72 mg) close to the battery contact clips soldered directly on the board. Few diodes and a moderate number of passive SMD components complete the circuitry.

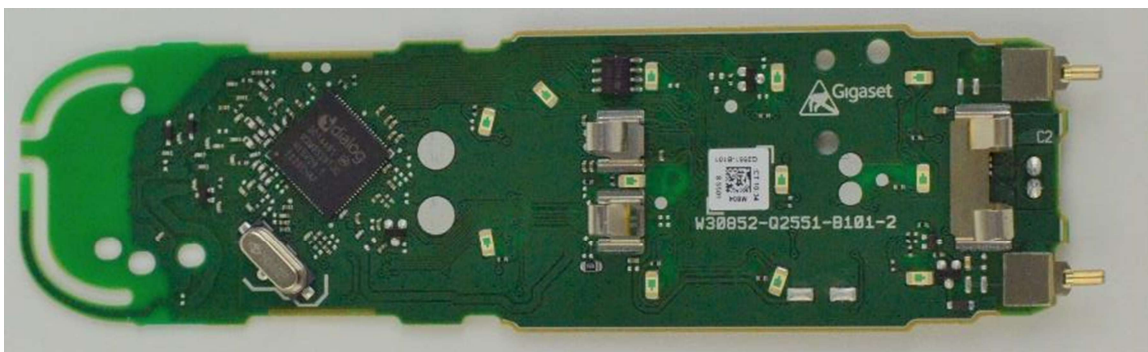

Figure 49 : Cordless phone handset teardown – mainboard

The handset is typically shipped in a bundle with the base station and power supply.



Figure 50 : Cordless phone base station teardown – overview

The upper and lower shell of the base station are made of polymers, ABS again being a popular choice (Figure 51). The loudspeaker is attached to the upper shell. The key pad is made of silicon rubber and placed on the printed circuit board. The charging pins for the handset are internally connected with metal spring sheets to the same printed circuit boards. Loudspeaker and charging pins are both connected non-permanently to the board and as such can be removed easily.

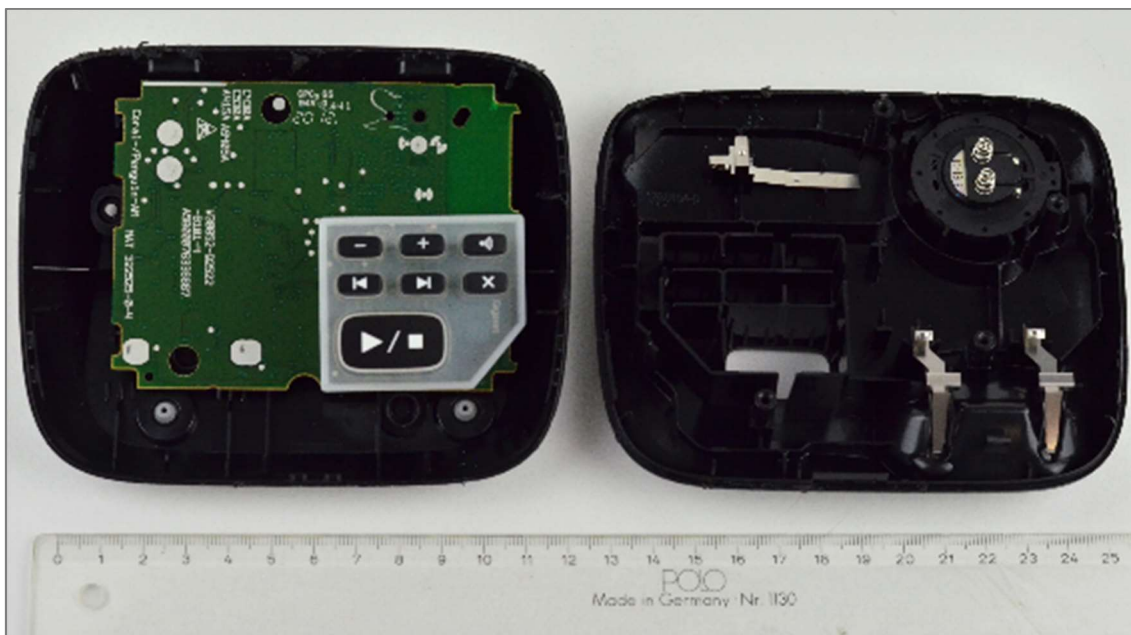

Figure 51 : Cordless phone base station teardown – cover (right) removed

The top side of the printed circuit board mainly acts as contact area (Figure 52). The electronic components are all assembled on the downside of the printed circuit board (Figure 53). The surface finish of this double-sided FR4 board is apparently chemical tin as can be seen on the contact areas.

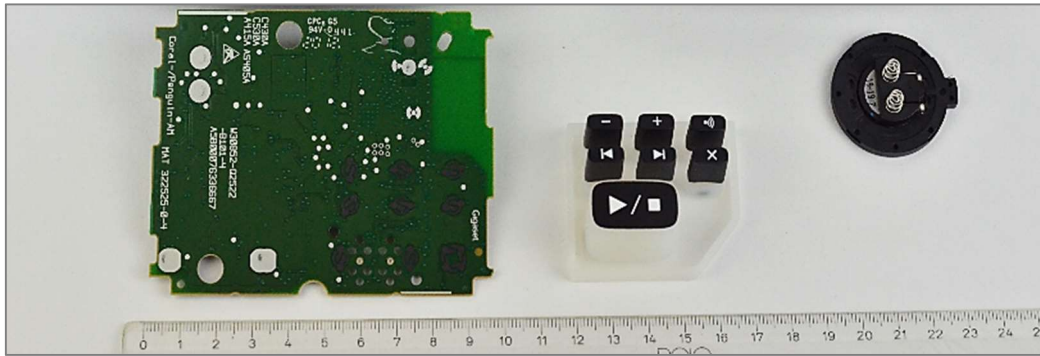

Figure 52 : Cordless phone base station teardown – printed circuit board, key pad, loudspeaker

The main System-on-Chip integrates the functionality of a digital baseband controller, analog interface, RF transceiver, and power amplifier (QFP88 package). There are more components on this board than in the handset. The power connector and the telephone line RJ plug are both soldered on the printed circuit board.

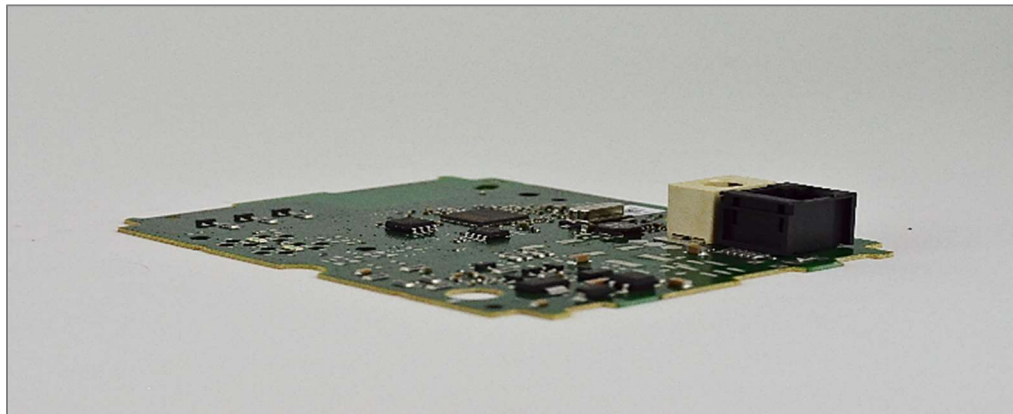

Figure 53 : Cordless phone base station teardown – printed circuit board downside

3.1.3.2. Use phase power consumption

To reduce the risk of health impacts through radiation measures are largely implemented to reduce radiation power of the handset when the phone is in proximity of the base station, and also transmission power of the base station is adapted when the handset is placed in the charging cradle of the base station. This feature is typically called ECO-DECT, but there is no harmonised definition for this term. Vendors use this term for power supplies with high efficiency, distance dependent regulation of transmission power of handset and/or base station, establishing a radio connection between both only when needed, or further measures to reduce power consumption or radio power.

The standby power consumption according to Stiftung Warentest of the charging cradle, i.e. base station where applicable is shown for the 40 models available on the market in Figure 54: 30 models include a base station, another 10 models do not come with a base station, only a charging cradle, and can be connected to telephony networks through a router with DECT functionality. The average standby power consumption of devices, where the charging cradle is integrated in a base station, is 0,6 W. For some models the standby power consumption reaches up to 0,9 W. For

those units, which do not include a base station, the average standby power consumption is 0,12 W and the maximum 0,4 W.

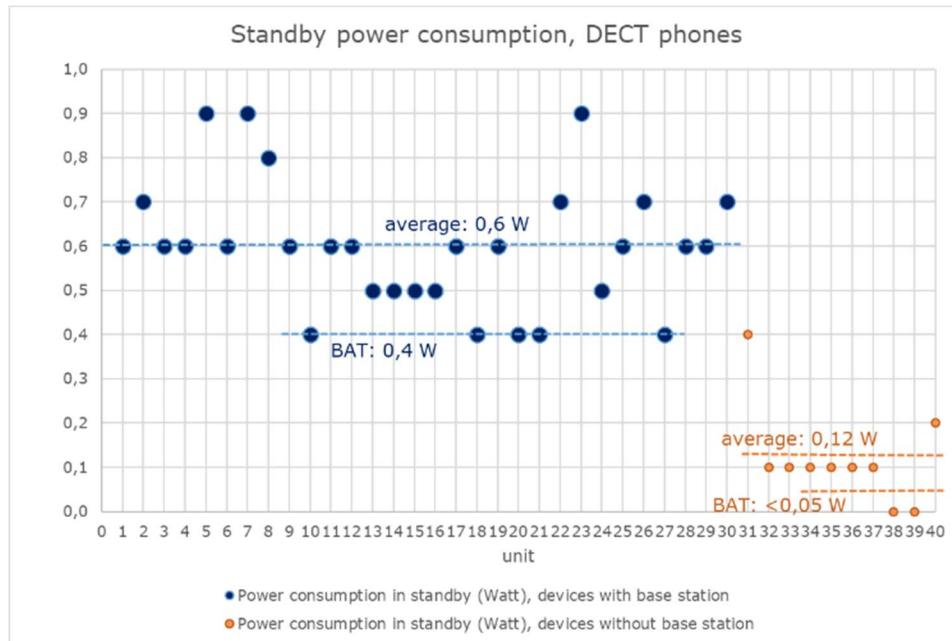

Figure 54 : Standby power consumption, DECT phones / charging cradle / base station (data by Stiftung Warentest, compilation by Fraunhofer IZM)

With fully charged batteries in average 17,7 hours of phone calls are feasible (Figure 55). Most of the phones are in a similar range, but the best tested device allows for more than twice the talk time. The average time to charge the batteries is 7,6 hours.

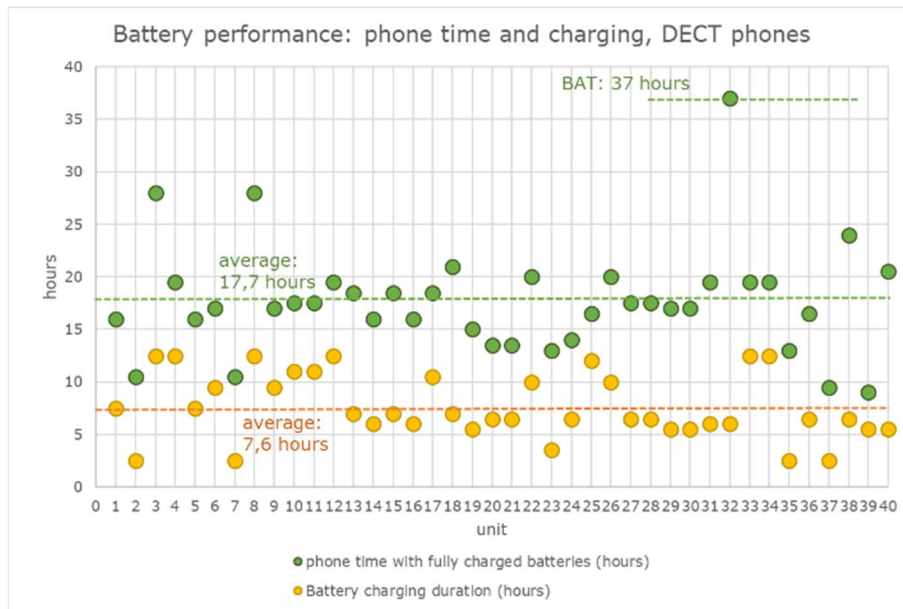

Figure 55 : Phone call times with fully charged batteries and charging times, DECT phones (data by Stiftung Warentest, compilation by Fraunhofer IZM)

In standby fully charged batteries of DECT phones last in average 11,9 days before being fully drained. This applies to standard settings for the base station / router (.). With eco settings of the base station / router the batteries only last for 7,4 days in average as the handset has to check for radio connectivity almost constantly. Thus, an

eco-mode on the base station side comes at the expense of additional power consumption for the handset.

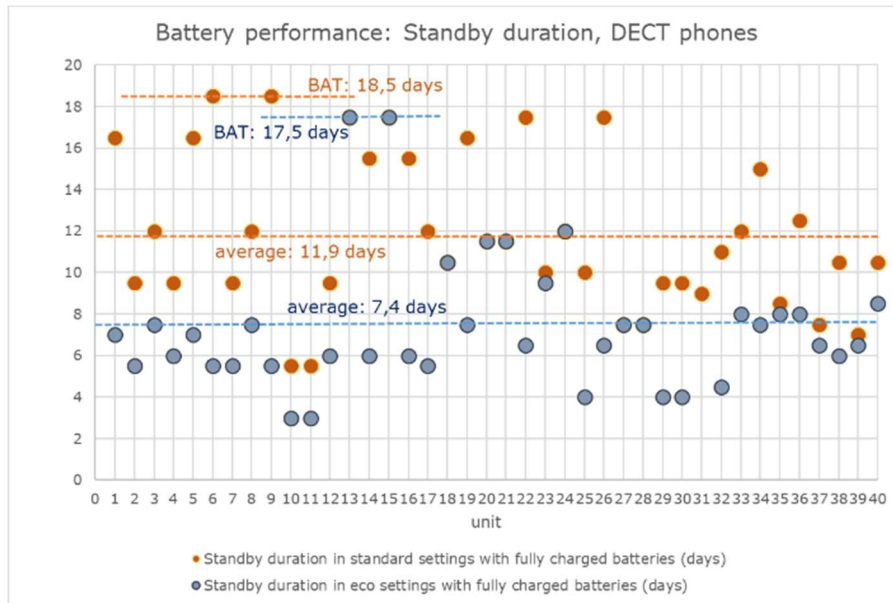

Figure 56 : Standby duration in standard and eco mode, DECT phones (data by Stiftung Warentest, compilation by Fraunhofer IZM)

3.1.3.3. End of life phase

Collection rates for cordless phones are stated to be significantly higher than for mobile phones: 22% in Germany as of 2012 (Sander et al. 2019). Reasons for this finding are speculative, but it might be related to less privacy concerns than with mobile phones although also cordless phones can store contact data. Due to the typically lower material value of smartphones cordless phones are rather likely to go through a shredding and sorting process where major plastics parts are separated from the printed circuit board, which is then recycled in a copper smelter.

3.2. Average Technology: Components

Smartphones and tablets are composed of frequently more than 1000 hardware components - plus software. Feature phones and cordless phones are less complex.

3.2.1. Frame and back cover

Frame and back cover are the endo- and exo-skeleton of smartphones and tablets and are typically made of metals (mainly aluminium, and steel, occasionally copper as inside foil or coating for thermal and electrical reasons), plastics, and glass. Rubber inlays are frequently attached to the frame parts. Some designs come with a mid-frame. Frames and covers frequently feature additional functions as they incorporate glass covers for camera lenses, act as substrate for antenna structures (in particular Samsung makes use of moulded and metallised 3D frame parts as antenna components), or house thread inlays. As such, frame and back cover parts are typically not mono-materials.

3.2.2. Display assembly

The display assembly of smartphones is the interface that allows users to visualise information on their devices. A standard three-part display assembly consists of a display, a capacitive layer (touch screen) and a glass cover (Cordella et al. 2020).

According to Xiaomi, most Chinese brands currently use two-part display assembly i.e. touch screen and display. For most models on the market, such parts are glued or fused together and form one unit. This glued or fused sandwich design has some technical advantages with respect to optical properties (light transmission) and overall stability of the display assembly. Adhesives in display assemblies also fulfil a sealing function, thus enhancing water tightness. The use of pressure sensitive adhesives also enhances robustness of display assemblies due to "the physical nature of PSAs: The viscoelastic behavior supports resistance of structures to impact as the PSAs are capable to absorb a portion of the impact energy. Specially designed PSAs are being used for bonding of smartphones with a balance of strength to hold the structure on the one side and maximizing impact absorption on the other." (stakeholder input by German Adhesives Association IVK) How widespread these types of PSA are implemented in actual adhesive bonds for display assemblies is not known.

Whereas among smartphones a full-area bonding between the display unit and the touch-sensitive digitizer unit is common, this was not the case for tablets until few years ago: The digitizer unit could be easily disassembled from the display unit, see Figure 57.

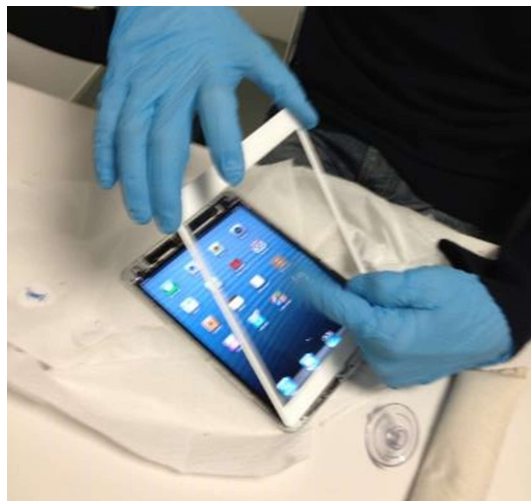

Figure 57 : Demonstration of a still functioning digitizer unit of a tablet lifted off from the LCD unit

Display technologies comprise (Cordella et al. 2020):

1. Liquid Crystal Displays (LCDs), where a backlight is transmitted through liquid crystals, which change orientation when current is applied or switched off, polarizers and colour filters generating the different colours. The light is not being generated by the display itself. The light source for LCDs in mobile phones are LEDs;

LED displays, where colour LEDs represent individual pixels, are only used in larger displays, not those of smartphones.

2. OLED (Organic Light-Emitting Diode), where emissive pixels produce light. OLED where first used in high-end phones but penetrate now also the mid-range market; OLED are increasingly popular since they have a very fast response time and allow making curved and flexible screens, good view angles and an always-on display mode; according to 2018 market data costs of OLED smartphone displays where roughly 50% higher than LCD displays, which is a major cost difference as the display is typically one of the most expensive smartphone parts;

3. AMOLED (Active Matrix OLED) is a type of OLED technology used in smartphones, which is more energy efficient.

The touch screen consists of a capacitive layer typically based on Projected Capacitive Touch (PCT) technology. A voltage is applied to a grid to create a uniform electrostatic field. When a conductive object touches the PCT panel, it distorts the electrostatic field of the electrodes that are nearby the touch point. This is measurable as a change in the electrode capacitance. If a finger bridges the gap between two of the electrodes, the charge field is further affected. The capacitance can be changed and measured at every individual point on the grid. Therefore, this system is able to accurately estimate the touch position (Du 2016).

The glass cover is the outer part of a screen. Modern smartphones feature a toughened glass (commonly an alkali-aluminosilicate glass). This increases the durability of the display in terms of scratch- and drop-resistance and ensures a clear visualisation of images. Strengthened glass panels are getting more and more durable. Corning claims that its Gorilla Glass offers better protection with each generation. Such kind of glass is chemically altered via ion exchange to improve their strength. The process involves the exchange of sodium ions in the glass material with larger potassium ions under high temperature. The result is a material that is more impact resistant and scratch-proof than regular glass (Cordella et al. 2020).

3.2.3. Batteries

3.2.3.1. Typical applications and manufacturers / suppliers

There is a large variety of battery cell and pack designs for phones and tablets. While lower cost DECT phones might still feature replaceable standard sized (e.g. AA or AAA) rechargeable battery cells, most smart phones require specialized battery cells allowing for a high performance with lowest volumetric and gravimetric footprint.

The market share of replaceable NiMH rechargeable batteries in phones has been decreasing over the last years (Pillot 2017). It can be assumed that the majority of mobile phone batteries today is LIB-based and hence features model specific battery packs and cells. For cordless phones NiMH rechargeable batteries are the most relevant type.

The largest suppliers of battery cells for smart portable devices are Amperex Technology (ATL), Samsung SDI, LG Chem, Zhuhai Cosmx Battery, TianJin Lishen Battery, Liwinon, BYD and Murata Manufacturing.

3.2.3.2. Battery pack design

Smart portable devices feature a high computing power and often large displays covering the device surface. Both have a high power demand and hence devices require high energy batteries allowing for a combined standby/use runtime of one day to few days. Large battery packs are often no option, since both smart phones and tablets have tight volume and weight restrictions with respect to battery assembly space. Battery packs hence are often integrated next to other electronics to fit into the space not needed by ports, cameras, control buttons, displays and other components whose arrangement is determined by design. Li ion batteries are typically manufactured in foils, that is as a laminate of cathode, separator with sorbed electrolyte and anode. The foils are then folded into the required form factor which is then finished as the battery module. Smartphone and tablet battery packs are often designed rather minimalistic consisting of one or few battery cells and a battery management board often glued to the side of battery cells. Battery packs usually

integrate their own protective circuitry. For safety reasons overcharging and overheating must be prevented at least in case of Li ion batteries.

Newest generation smart phones have battery packs with a width of only 3 to 4 mm and cover a size of 60 mm x 70 mm up to 80 mm x 150 mm²⁴. The high aspect ratio allows for flat device designs. In addition, the high surface area of the battery pack allows for passive cooling concepts by thermal conduction through the device case. Following this concept, charge rates of 0.5 to 0.7 C are possible keeping the battery temperature below 45 °C (Barsukov and Qian 2013). Xiaomi states at present a normal charging rate of 1.0C. In extreme cases, it can go up to 5.0C.

(a) Configuration, voltage

There is a clear market trend to higher capacity battery packs for smart portable devices (Pillot 2017).

Depending on display size, smart phones feature battery packs of 2500 (e.g. iPhone X) to more than 4000 mAh (e.g. Huawei P30 Pro) capacity. Typically, smart phone battery packs consist of one single Lithium-ion battery (LIB)-cell (1s1p²⁵, Samsung, Apple, Huawei). In some cases, parallel configurations are used, often to realize more complex battery pack formats (e.g. iPhone X and Xs). Xiaomi and VIVO both have 2S1P batteries in mass production at present. Series connections of battery cells are not reported for smart phones, since all devices are designed for charging via USB ports with a voltage of 5 V. Smart phone battery pack voltage hence is around 3.7 V to 3.8 V.

A broader variety of battery configurations can be observed for tablets. Single cell packs (1s1p) with a capacity of 5 to 7 Ah are utilized for smaller tablets below a display size of 10 inches. For increased battery run time or due to format flexibility, a number of tablets have parallel connections of two or three LIB- cells thereby realizing battery capacities of up to 10 Ah (e.g. Google Nexus, Galaxy Tab / Galaxy Note, iPad, iPad Air, iPad Pro). This configuration also allows for charging via USB.

A number of high end or heavy duty tablets utilize series connections of battery cells thereby realizing higher pack voltages of 7.5 V to 7.8 V in 2s1p or 2s2p configuration (e.g. Microsoft Surface Pro). While these concepts require special charging equipment, the higher pack voltage can allow for higher energy efficiency, e.g. of the display lighting and other electronic components.

(b) Battery Management Systems

Smart batteries make use of battery management systems (BMS) composed of dedicated integrated circuits (IC) to track and report lifetime data in addition to carrying out safety and performance-related tasks such as monitoring battery voltage, current, and temperature. Due to space constraints, printed circuit boards (PCB) embedded in smartphone batteries tend to be minimalistic. Most smartphones only employ simple BMS that provide the essential safety features to prevent overcharge overdischarge and other harmful events, communicate with the power adapter for charging and report the state of charge and battery temperature to the operating system. Some manufacturers employ more complex BMS that include a so-called fuel gauge IC that track and report more elaborate data on the status of the battery.

²⁴ <https://www.samsungsdi.com/lithium-ion-battery/it-devices/tablet.html>

²⁵ XsYp means a configuration of X battery cells in series connection and Y of these series strings in parallel connection OR Y battery cells in parallel connection and X of these parallel strings in series connection.

Smart batteries equipped with such BMS commonly store basic information about the battery, such as a unique ID, the manufacturing date, and the design capacity. They also estimate the state of health (SOH), indicating the remaining capacity of an ageing battery relative to the initial capacity the battery was designed for. These smart battery BMS are more often found in premium smartphones.

The advantage of more complex BMS that estimate the SOH is that users are provided with an indicator of the status of their battery, including age, number of charge/discharge cycles, and state of health. This type of data may be useful to determine whether a battery is fit for continued use. It also enables a reuse market where concrete statements on the battery status can be made to ensure transparent transactions.

3.2.3.3. Battery cell design and chemistry

(a) Design

With respect to cell formats, there is a clear trend towards Pouch-type LIB-cells in smartphones and tablets. Due to their robust exterior, prismatic hard case cells feature good mechanical safety properties and hence have been utilized in phones and other mobile devices in the past. The metallic case however adds additional weight to the battery. Furthermore, it is not possible to deviate from rectangular cell shapes, leaving little room for customization of the battery cell format and hence pack design.

Pouch type cells on the other hand (consisting of a thin Pouch bag of Aluminum laminated with Nylon and Polyurethane) can easily be customized in size and shape. Volume utilization in phones and tablets is the strongest driver for application specific cell design. Recently, first smartphones came to the market featuring non-rectangular cell designs. With respect to non-rectangular pack designs, consisting of two or more cells (e.g. 1s2p configuration), non-rectangular cell designs may feature higher energy densities on pack level and might allow for lower production costs in mass production.

Globally, prismatic hard case type cells for cellular applications dropped from a demand of 1.2 billion cells/a in 2010 to about 250 million cells/a in 2019. The market size of Pouch type cells in cellular applications has been on the level of 1.4 billion cells/a in 2018 and 2019.

In the tablet segment, neither cylindrical (standardized) NiMH cells nor prismatic hard case LIB cells play a role. Due to the high energy demand of tablets, the market is completely dominated by Pouch-type LIB cells on a level of about 200 million cells/a in 2018 and 2019.

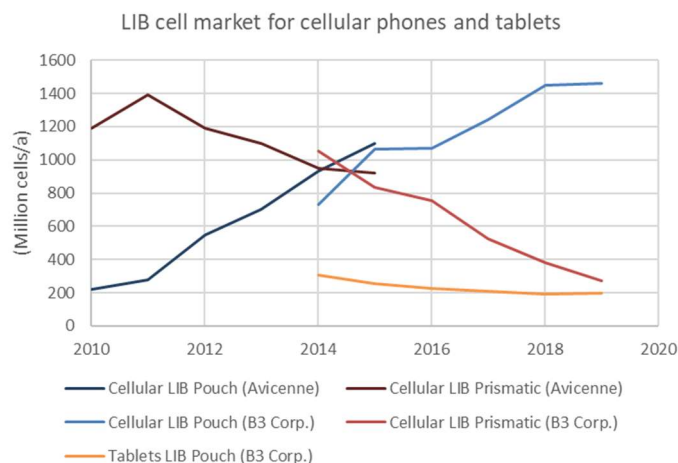

Figure 58 : Development of LIB markets for cellular phones and tablets. Data taken from (Pillot 2017; B3 Corp.; B3 Corp.)

(b) Chemistry and materials

If neglecting the small share of NiMH powered phones, the majority of smart phones and tablets on the market feature LiCoO₂ (LCO) and graphite based cell chemistries with liquid or polymer gel electrolytes. This is the case for almost all small portable devices. LCO based LIB feature a high voltage, good cycling performance and energy density (Warner 2019; B3 Corp.). Today's smart phone battery cells feature energy densities of up to 750 Wh/l. Although there are other cathode materials available on the market, which are lower cost and have a higher capacity and significantly better safety properties, LCO is still the material of choice. In most small portable devices, cost of the battery of few Euros is only a small share of the total device cost of often several hundred Euros. As compared to EV applications with large batteries, the safety properties on material level are also not of highest concern, since high temperature or mechanical penetration does seldom occur. However, there are actually reported cases, where batteries in mobile devices became a safety issue, the Galaxy Note 7 being the most popular case (BBC 2017).

On the other hand, LIB cell manufacturers are very experienced with the production of LCO based batteries and continuous improvements have lead to LCO smartphone batteries still featuring one of the highest energy densities of all LIB cells.

When considering the electrode level, the high energy densities are often not introduced by utilization of a high specific capacity which is only in the range of 160 to 170 mAh/g for LCO, and up to 185 mAh/g maximum at present. Active material particle densities in smartphone batteries however are often significantly higher as compared to EV batteries. Low porosities are achieved by tailored particle size distributions and high compression during calendaring of the electrodes.

Similarly important, there has been a trend towards higher charge cut-off voltages for smartphone batteries (Kalluri et al. 2017; Zhang et al. 2018). This is realized by surface modification of LCO particles resulting in higher stability at high charging voltages. As the electrode potentials drive electrochemical reactions, such as oxidative decomposition of the electrolyte whose rate increases with higher electrode potentials, this trend rather reduces battery lifetime. According to Xiaomi, at present, most cell platforms used in mobile phone batteries have a cut-off voltage of 4.45V, with an average discharge voltage of 3.87~4.0V. In some low-end range, some batteries still retain the 4.4V capacity, and the average discharge voltage is about 3.85~3.97V.

In terms of energy density, the voltage increase translates into an improvement of 3%. The higher cell voltage might however reduce losses in the device electronics and hence have benefits for the runtime of the device. It can be expected that the trend towards higher capacity utilization of LCO and higher voltage will continue in the next years.

For a significant improvement of energy density it is likely that graphite / silicon or graphite / silicon oxide anodes will be utilized in the next generation of portable device LIB cells. Today, artificial or natural graphite still seems the material of choice. However, for the realization of energy densities of 800 Wh/l or more, the transition towards Si-alloying anodes is likely (Thielmann 2017).

3.2.3.4. Battery durability

The capacity of LIB inevitably decreases over time and with use. Battery durability is usually described by a battery's specific cycle life and calendar life. Cycle life denotes the number of charge/discharge cycles (amount of charge equivalent to the battery's initial capacity) the battery can withstand before its capacity decreases below a certain level (e.g. 80 % or 60 % of the initial capacity). Calendar life denotes the capacity fade that occurs even as the battery is not in active use (e.g. while in storage). Many studies have examined the underlying aging mechanisms associated with capacity fade in lithium-ion batteries. The causes are chemical and physical processes taking place inside the battery cell, which are influenced by a number of factors. Among the dominant ageing mechanisms are loss of active and accessible electrode material and active lithium-ions, loss of conductivity in the electrodes or the electrolyte, and decomposition of the electrolyte. Factors with a considerable potential to accelerate capacity fade include high and low temperatures, high state of charge (SOC), high depth of discharge (DOD), high use intensity (high number of charge/discharge cycles), and abusive use such as overcharge and overdischarge (both of which are commonly prevented by batteries' safety circuitry). Besides those, the quality control of the manufacturing process, such as the purity of materials and exclusion of water, play a critical role determining the quality of manufactured cells and their endurance during the use phase.

The durability of batteries is commonly stated in charging cycles before the initially available capacity or the design capacity drops below a defined threshold. The threshold is often defined at 80 % or 60 % state of health (SOH). This cycle withstand or cycle stability can be measured under laboratory conditions using standards such as EN 61960. Smartphone and tablet cells are frequently able to withstand 500, 1.000 and more charging cycles under such controlled conditions. However, the use patterns and influencing factors that occur under real use conditions in the field can be accounted for in laboratory testing only to a limited degree.

A study analyzing a database containing more than 5.600 data sets on battery health from a range of Apple iPhone smartphones and iPad tablets provided insights into the durability of the batteries under real-life use conditions (Clemm et al. 2016b). The data stems from users of the coconutBattery software²⁶ that have opted to upload data on the health status of their device batteries into the software's database.

Figure 59 plots the SOH data from iPhone batteries against the number of charge/discharge cycles. It can be observed that the share of batteries with an SOH above 80 % and 60 % steadily decreases over the course of 1.000 charge/discharge cycles, as is expected. While the data scatters considerably, a general trend of

²⁶ <https://coconut-flavour.com/coconutbattery/>

decreasing capacity with increasing cycle count can clearly be observed. Among the batteries that have been subjected to more than 800 cycles, 55 % of the batteries in the database were able to retain 80 % or more of their design capacity, 88 % percent of the batteries retained 60 % or more, and 12 % had less than 60 % of their design capacity left to power the devices on a single charge. It should be noted that due to the data acquisition procedure described above, only batteries that are in active use can possibly contribute data to the database. Therefore, the database does not reflect the number of batteries that users may have considered spent and replaced, which results in a bias towards more durable batteries. Accounting for this bias, the data appears to indicate that smartphone batteries are technically able to withstand a high number of charge/discharge cycle over the course of several years while retaining a high share of their initial capacity.

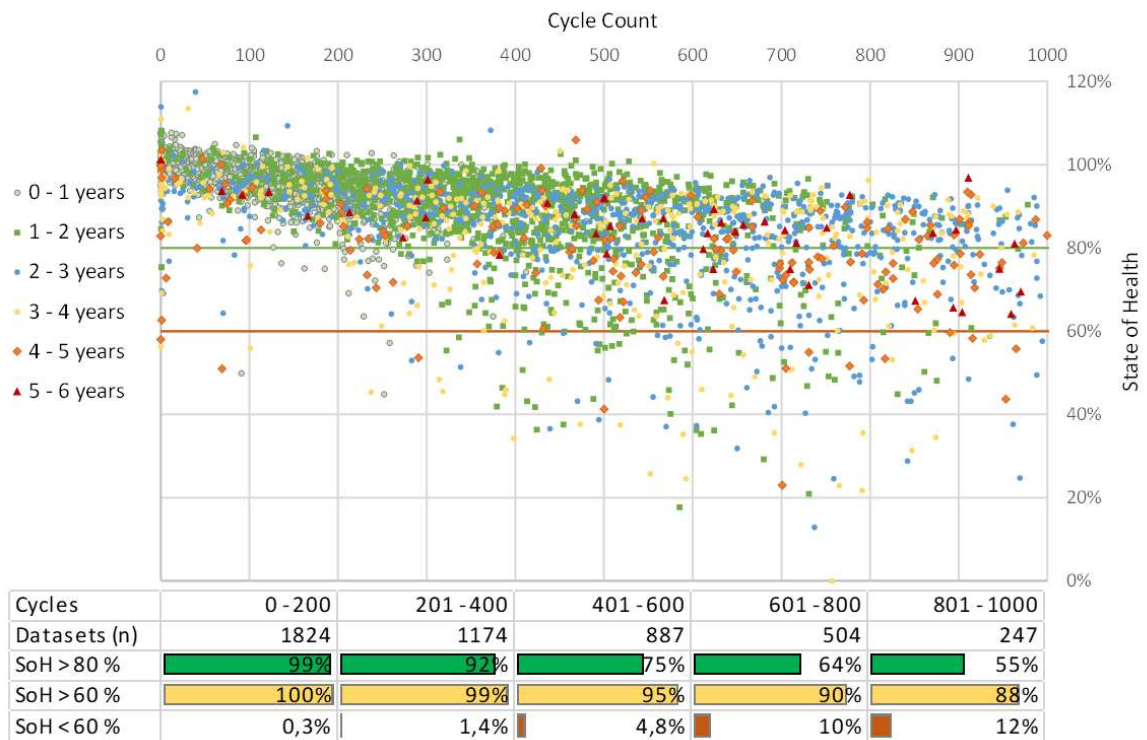

Figure 59 : State of health (SOH) of smartphone batteries, clustered into intervals of battery age in years, over the course of 1.000 charging cycles (Clemm et al. 2016b).

The statistics present the share of data points in each interval of 200 charging cycles that have retained at least 80 % and 60 % SOH.

The same analysis was carried out for the data on the SOH of iPad batteries contained in the coconutBattery database (Figure 60), but only up to 500 charge/discharge cycles due to data scarcity beyond 500 cycles. 90 % of all batteries that contributed data to the database reported SOH above 80 % even after several hundred charging cycles over several years.

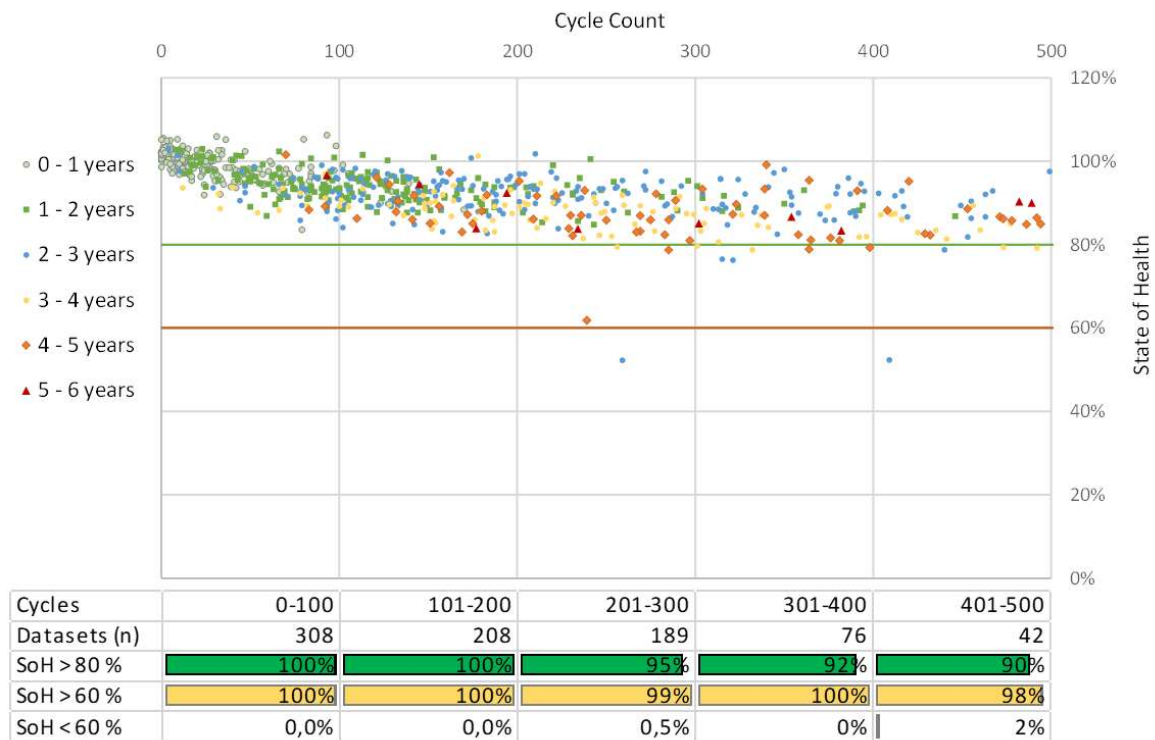

Figure 60 : State of health (SOH) of tablet batteries, clustered into intervals of battery age in years, over the course of 500 charging cycles. The statistics below present the share of data points in each interval that have retained at least 80 % and 60 % SOH (Clemm et al. 2016b).

The battery capacity decreases with an increasing number of loading cycles. For a broader range of tablet models this effect has been documented by a study the Fraunhofer IZM has conducted for the German Environmental Protection Agency (UBA). In this study, Fraunhofer IZM (Clemm et al. 2016a) cycled batteries from different tablets (slates) sold in 2013.

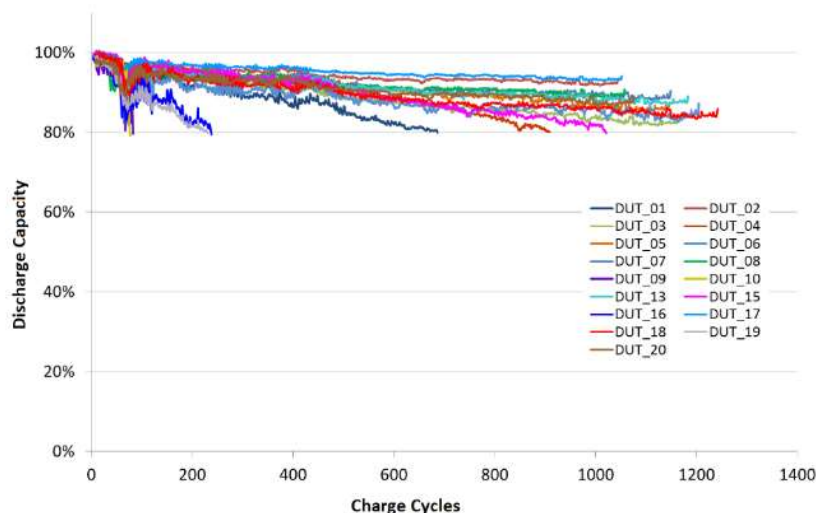

Figure 61: Tablet battery capacity deterioration over load cycles (Source: Fraunhofer IZM)

The diagram above shows that with increasing battery lifetime and load cycles the capacity of battery deteriorates. There are some tablet batteries, which failed early on but this might be due to the generic cycle protocol applied. The test standard EN 61960 requires to apply the charging and discharging routine as defined by the manufacturer, which was not known for these batteries extracted from various tablets. A valid conclusion from these tests however is, that many batteries under moderate test conditions, but with a cycling between 0% charge and full charge, achieve 1000 charging cycles at well above 80% remaining capacity. This indicates that with proper handling a state-of-the art battery should not be a limiting factor for tablet use in the first 3 years even for a power user with a daily full charge.

3.2.3.5. Battery integration

Based on a stakeholder input by the German Adhesives Association IVK adhesive based integration of embedded batteries can be described as follows:

Due to the close contact with (metal) housing and/or frames adhesives enable an efficient heat management of the batteries. As thermal stress reduces battery lifetime, this design tends to increase battery lifetime. Examples of adhesive-based technologies being used, all of which include the possibility of easy demounting are:

- Batteries are mounted into the housing with double sided PSA tapes (pressure sensitive adhesive tapes) with stretch-release-properties that loose adhesion simply via stretching and thus allow for simple removal of the battery. This is the most wide-spread technology. The stretching can be performed manually, using finger grip, optionally with simple mechanical tools.
- An alternative are PSA systems with adhesion properties that are sensitive to contact with ethanol. For dismantling purposes, droplets of ethanol are brought into contact with the adhesive which loses adhesion immediately. Together with a short mechanical impact, the batteries can then be easily removed from the devices.
- The third direction is the use of battery wrapping technology. The battery is wrapped into a PET film which is bonded to the housing with a double-sided PSA tape with two different adhesive sides. The side showing to the battery has relatively low adhesion, allowing for easy removal by applying a peeling movement to the battery. This movement is applied through a pull tab attached to the battery wrap.

Ageing of adhesives might be an issue, as over time properties of pull strips and interfaces might change and result in pull tabs being ripped off instead of pulling of the battery.

3.2.4. Semiconductors

There is a multitude of various integrated circuits in smartphones and tablets, and significantly less in feature phones and cordless phones.

A list of integrated circuits extracted from the bill of materials of a flagship smartphone as of 2016 is provided in Table 17. In total there are 55 IC packages, of which some are multi-chip modules, such as flash memory, DRAM, and the NFC controller.

Furthermore this list of integrated circuits includes the camera modules with the sensor chips, the driver ICs for the display, which are mounted chip-on-glass on the LCD glass, and numerous ICs for the power management, radio interfaces and power amplifiers, and for the various user interfaces, including audio.

Package types as listed in this BOM include Flip Chips, which are ICs mounted active side down directly on the board or more common as wafer-level package with a re-routing on the chip to allow for a more relaxed pitch. In this example the processor package is assembled on top of the DRAM package (i.e., "package-on-package").

Table 17 : Integrated Circuits in an exemplary smartphone, compilation based on (Electronicproducts 2016)

Function	Type	Quantity	Component Description	Package type
Apps Processing / Baseband	Logic	1	Apps / Baseband Processor, Quad-Core, GPU, 14nm, PoP, 1 die	BGA , PoP
BT / FM / GPS / WLAN	Analog	1	RF Switch	DFN
Camera	Camera	1	Primary Camera Module, 12MP, BSI CMOS, 1/2.5" Format, Auto Focus Lens, Optical Image Stabilization, 6P Lens	Camera module
Camera	Camera	1	Secondary Camera Module, 5MP, BSI CMOS, 1/4" Format, Fixed Lens, 6P Lens	Camera module
Display / Touchscreen	Logic	1	Touchscreen Controller, Capacitive	BGA
Display / Touchscreen	Logic	1	Display Driver IC, Integrated Timing Controller, Integrated Source Driver IC	COG
Memory	Memory	1	Flash, UFS NAND, 32GB, MLC , 4 dice @ 8GB, 1 die controller	BGA
Memory	Memory	1	SDRAM, Mobile DDR4, 4GB, PoP, 4 dice @ 1GB each	BGA , PoP
Memory	Memory	1	EEPROM	DFN
Memory	Memory	1	Flash, NOR, 32Mb, SPI	DFN
Power Management	Analog	1	Regulator	DFN
Power Management	Analog	1	Wireless Power Receiver	Flip Chip
Power Management	Analog	1	Motor Driver	DFN
Power Management	Analog	1	Load Switch	Flip Chip
Power Management	Analog	6	Power Management IC	Flip Chip
Power Management	Analog	1	Regulator, LDO, 2.85V, 250mA, 2%, Ultra Low Noise, High PSRR	DFN
Power Management	Analog	1	Load Switch, Slew Rate Controlled	DFN
RF / PA	Analog	1	Antenna Switch	SMD
RF / PA	Analog	2	Transmit Module	SMD
RF / PA	Analog	6	LNA, LTE Receiver	DFN
RF / PA	Analog	4	RF Switch	DFN
RF / PA	Analog	5	Antenna Switch	SMD
RF / PA	Analog	1	RF Transceiver, GSM/EDGE/HSPA+/CDMA 1X EVDO/TD-SCDMA/LTE, GPS/GLONASS/BEIDOU, 28nm	Flip Chip
RF / PA	Analog	1	RF Transceiver, GPS/GLONASS/BEIDOU Receiver, 28nm	Flip Chip
RF / PA	Analog	1	LNA	DFN
RF / PA	Analog	1	RF Switch	SMD
RF / PA	Analog	1	Antenna Tuner	Flip Chip
User Interface	Analog	1	Audio Power Amplifier	Flip Chip
User Interface	Analog	1	Overvoltage Protection Controller	Flip Chip
User Interface	Logic	1	Audio Codec	Flip Chip
User Interface	Logic	1	Audio / Voice Processor, Programmable DSP Core	Flip Chip
User Interface	Logic	1	Buffer	SOT953
User Interface	Analog	1	Analog IC	DFN
User Interface	Logic	1	AND Gate	SOT953
User Interface	Logic	1	NFC Controller, 2 dice	BGA
User Interface	Logic	1	Logic IC	LGA
User Interface	Logic	1	Heart Rate Monitor IC	BGA
User Interface	Analog	1	Voltage Comparator	MicroPak
User Interface	Logic	1	Camera OIS Controller	BGA
User Interface	Analog	4	Hall Effect Sensor	SMD
User Interface	Analog	1	Hall Effect Sensor	Flip Chip
User Interface	Analog	1	Analog IC	Flip Chip
User Interface	Logic	1	MCU, 8-Bit, 16K Bytes Flash, 256 Bytes RAM	QFN

In summary, the data on semiconductors (integrated circuits) in the aforementioned exemplary flagship smartphone is compiled in Table 18: In total, there are 2,13 cm² of flip chip ICs, another 0,8 cm² of BGA and LGA packages, which typically have a die (semiconductor area) to package ratio of 70% to almost 100% and occasionally above. Less sophisticated semiconductor packages with few leads or pads only make up for another 1,25 cm², but they contain significantly less die area. This is important to understand as environmental impacts of semiconductors scale with processed semiconductor area (and other parameters, such as technology node, complexity, type of application) rather than with the weight of the packaged chip (Yin and Wang 2013).

Table 18 : Aggregated semiconductor parameters for an exemplary smartphone

Parameter	Specific ICs (CPU, DRAM, Flash)	Flip chips, chip-on-glass	BGA (Ball grid array), LGA (Land grid array)	QFN (Quad flat no lead package), SOT (Small outline package)	All IC packages
Package size (cm ²)	3,75	2,13	0,80	1,25	7,92
Die to package size ratio		100%	70-95% ²⁷	10-40%	
Die area (cm ²)		2,13	0,64	0,38	
approx. weight (g)			0,18	0,16	

Semiconductor technology and functionality for smartphones and tablets is progressing rapidly: Latest semiconductors for 5G increasingly feature also advanced functionality in terms of improved gaming, video streaming, and on-device Artificial Intelligence (AI).

3.2.4.1. Processors

The processor of a smartphone is designed as a "System-on-a-Chip" or SoC, which might be single semiconductor chip or several chips in one package. This comprises the CPU (Central Processing Unit), the GPU (Graphics Processing Unit), the modem, the display and video processors, and other functionalities. Most smartphones use the same processor architecture by ARM²⁸. Major chip manufacturers are Qualcomm with the most widely spread Snapdragon chips, Samsung (Exynos), Apple (A13 Bionic being the latest version), HiSilicon, MediaTek and Unisoc.

Technology nodes for smartphone processors range from 28 nm to 6/7 nm. With shrinking physical dimensions the overall energy efficiency of data processing increases.

Smartphone and tablet processors are typically mounted on a high-density interconnect substrate (see Figure 62) or as an advanced wafer level package with redistribution layers for a less dense outwards routing. In any case these are not standard IC packages. As Figure 62 shows, the processor chip covers a large share of

²⁷ > 100% possible in case of multi-chip packages

²⁸ <https://www.arm.com/products/silicon-ip-cpu>

the overall package size and this chip to package ratio has increased further in recent years.

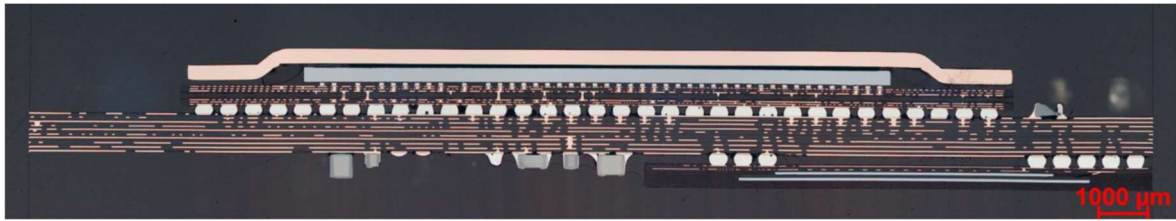

Figure 62 : Cross-section of a tablet processor (A6X) mounted on the mainboard

Typical processors for feature phones and cordless phones are less sophisticated. As feature phones do not need latest processors and also not the full bandwidth of smartphones, they can still rely on 2G telecom networks: The retro Nokia 3310 was released in 2017 with a MediaTek chipset introduced in 2012.

There is some information in the public domain on various mobile phone and tablet application processors packages. Exemplary data is provided in the following table. There are some major overlaps of processors used for both product segments, smartphones and tablet. For Windows tablets there is an overlap with the laptop segment as Intel processors are frequently used.

Table 19 : Selected mobile phone and tablet processors

Processor	product segment	2G	3G	4G	5G (sub-6 GHz)	5G (mmWave)	process [nm]	die area [mm ²]	package length [mm]	package width [mm]	package area [mm ²]	die-to-package ratio [%]
Qualcomm Snapdragon 845	high-end	yes	yes	yes	no	no	10	95,00	12,4	12,4	153,76	62%
Qualcomm Snapdragon 855	high-end and tablet	yes	yes	yes	ext	ext	7	73,27	12,7	12,7	161,29	45%
Qualcomm Snapdragon 865	high-end and tablet	yes	yes	yes	ext	ext	7	83,54			204,64	41%
Qualcomm Snapdragon 765	mid-range and tablet	yes	yes	yes	yes	yes	7		12,5	11,5	143,75	
Samsung Exynos 990	high-end and tablet	yes	yes	yes	ext	ext	7	91,83				
Samsung Exynos 9820	high-end and tablets	yes	yes	yes	no	no	8	127,00				
Huawei (HiSilicon) Kirin 990	high-end and tablet	yes	yes	yes	no	no	7	90,00				
Huawei (HiSilicon) Kirin 990 5G	high-end and tablet	yes	yes	yes	yes	no	7	113,31	15,2	14,4	218,88	52%
Huawei (HiSilicon) Kirin 980	high-end and tablet	no	yes	yes	no	no	7	74,13				
Huawei (HiSilicon) Kirin 970	high-end and tablet	no	yes	yes	no	no	10	96,72				
Apple A11	high-end	yes	yes	yes	no	no	10	87,66				
Apple A12	high-end and tablet	yes	yes	yes	no	no	7	83,27	14	14,5	203	41%
Apple A12X	tablet	no	no	no	no	no	7	122,00				
Apple A13	high-end	yes	yes	yes	no	no	7	98,48				
MediaTek Dimensity 1000	high-end	yes	yes	yes	yes	no	7					
MediaTek Helio X20	mid-range	yes	yes	yes	no	no	20	100,00				
MediaTek Helio P90	mid-range and tablet	no	yes	yes	no	no	12					
MediaTek Helio P95	low- to mid-range	no	yes	yes	no	no	12					
MediaTek Helio P35	low-end	no	yes	yes	no	no	12					
MediaTek Helio P22	low-end	no	yes	yes	no	no	12					
MediaTek Helio A25	low-end	no	yes	yes	no	no	12					
MediaTek MT6750	mid-range	no	yes	yes	no	no	28		13	13,4	174,2	
MediaTek MT6260	feature phone	yes	no	no	no	no	28	26,07	9,6	8,6	82,56	32%
Intel Celeron N3450	tablet	no	no	no	no	no	14					
Intel i7 1065G7	tablet	no	no	no	no	no	10	177,00	50	25	1250	14%

3.2.4.2. Memory (RAM)

Smartphones and tablets depend on RAM and an internal memory storage system.

With respect to the RAM, most mobile devices are shipped with LPDDR3 or LPDDR4, while some high-end smartphones are shipped with LPDDR4X RAM. LP stands for "Low-Power" and reduces the total voltage of these chips, making them highly efficient and giving mobile phones an extended battery life. LPDDR4 is more efficient and powerful than LPDDR3, while the LPDDR4X is the fastest, most efficient, but expensive. Newer generations of RAM are going to be introduced, such as LPDDR5²⁹. In terms of capacity, the current RAM usually ranges between 2 GB and 8 GB (Cordella et al. 2020).

Terminating or uninstalling unused apps can result in the availability of more RAM and can improve the performance of a smartphone (Cordella et al. 2020). Uninstalling apps also reduces flash memory limitations.

DRAM memory density per chip area increased over time significantly, as the technology nodes get smaller and smaller (Figure 63). Consequently, die sizes of the DRAM memory chip did not increase with increasing memory capacity.

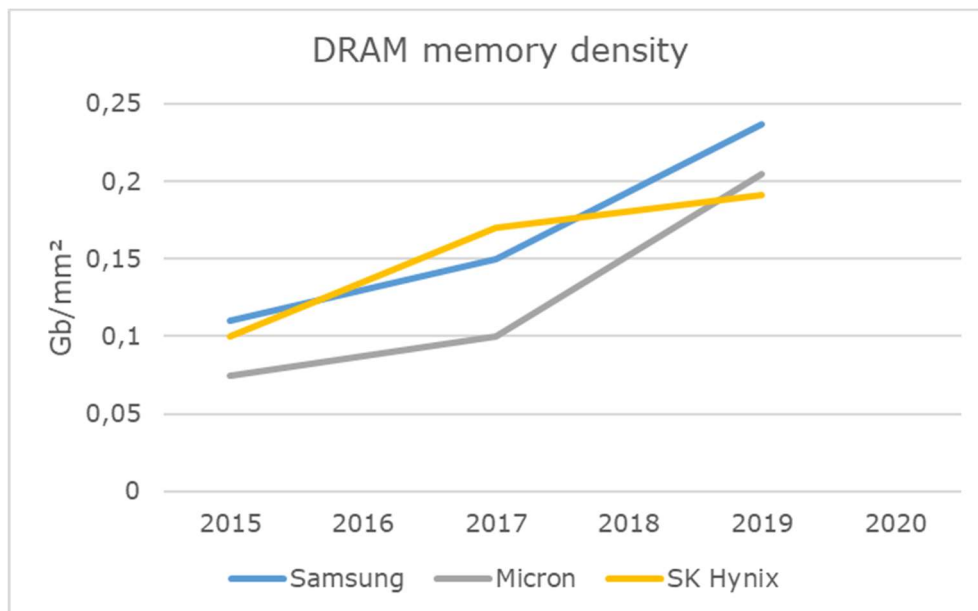

Figure 63 : DRAM memory density in Gb per mm² chip area

Typically there is only one DRAM semiconductor die in a packaged DRAM chip, but there are other designs in the market as well: On the downside of the board shown in Figure 62 there is the DRAM package, in this case even only one package out of two found in this tablet. In this one package there are 2 dice on top of each other.

A memory package as found in high-end smartphones³⁰ is a 12GB LPDDR5 package with eight individual 12 Gb dies, each with a die size of 53,53 mm², i.e. 428,24 mm² for storage in total.

²⁹ Production of LPDDR5 chips commenced mid 2019: <https://www.heise.de/newsticker/meldung/Erster-LPDDR5-RAM-fuer-High-End-Smartphones-ist-schneller-und-sparsamer-4475163.html>

³⁰ <https://www.techinsights.com/blog/xiaomi-mi-10-teardown-analysis>

3.2.4.3. Storage (Flash)

The internal memory storage system ranges typically from 32GB to 256GB, and up to 1TB in case of high-end devices.

Similar as with DRAM Flash memory storage density per area of semiconductor die is steadily increasing. The total memory capacity however is frequently split over several dice, and there is typically also a separate memory controller die in the package. Figure 64 depicts the trend of Gb/mm² for latest Flash memory technology as implemented by the four most important memory chip makers. These latest technologies with highest densities is typically used for flagship devices and highest memory capacities. For those memory capacities, which dominate the market, i.e. 32 to 128 GB, former technology generations are in use, which means semiconductor die areas in current phones and tablets do not directly scale with memory density, and actually for a given memory capacity the die area can vary widely due to different technology nodes.

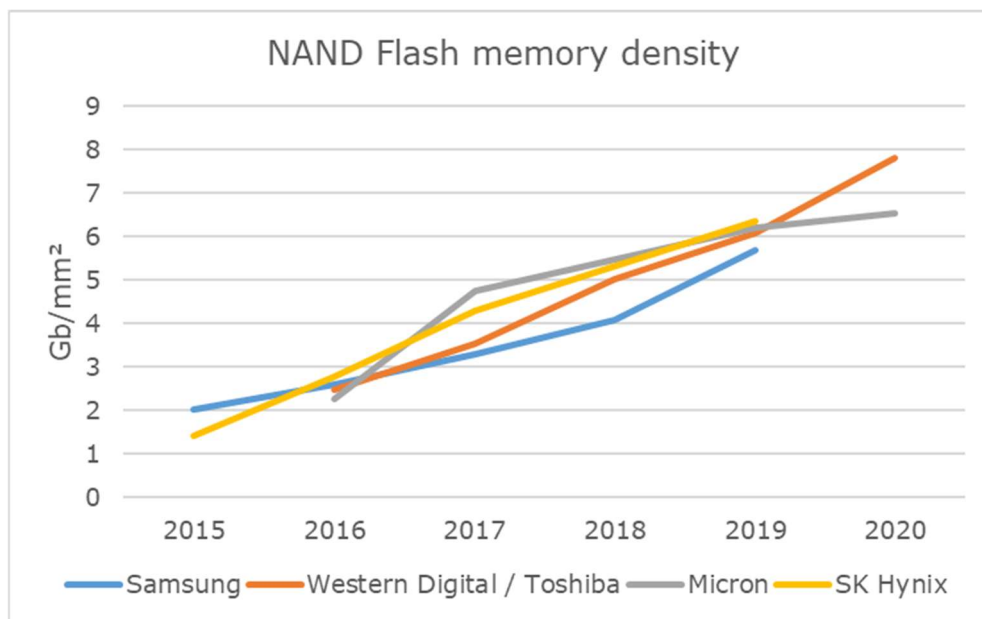

Figure 64 : Flash memory density in Gb per mm² chip area

Given these variances a good proxy for total die area is as follows :

- 32GB : 200 mm²
- 64GB : 300 mm²
- 128GB : 400 mm²

Flash memory packages are typically 11,5 x 13 mm² BGA packages regardless of the memory capacity. Occasionally memory is split over two such packages.

3.2.5. Camera

All smartphones come with rear-facing and front-shooting cameras. The camera comprises three main parts: the sensor (which detects light), the lens (the component in which light comes through), and the image processor. In the last years a strong trend towards better image quality increased the demand for multi-camera, super-high-resolution, and larger optical formats. This trend led to increased growth in the market value of CMOS Image Sensors (CIS). Latest flagship smartphones allow for 8K videos and up to 120x space zoom.

3.2.6. Connections

Until 2016 the 3.5mm headphone jack has been one of the oldest and most widely used connectors. Apple was the first company to remove it with the iPhone 7. Since then more and more phones enter the market without a headphone jack. Today, the connection with wired headphones is often made through a USB Type-C (Android) or Lightning (iOS) connector. However, it is not possible to charge the phone and use the headphones at the same time.

Universal Series Bus (USB) are typically the main wired interface of smartphones and tablets for data exchange with other devices. As such, USB connectors are an essential component of a device. The USB port is also used for battery charging. USB evolved over time, and the latest generation USB 4 now combines USB features with Apple's Thunderbolt technology, at twice the data rate compared to the former generation. USB 4 is specified to be backwards compatible with older USB versions, but according to a stakeholder comment, this is in practice not always the case. On the host side with USB 4 the connector remains to be Type C (Table 20).

Table 20 : USB Generations and Terminologies (Sosnowsky 2020)

Initial	nomenclature		Data rate	Speed classification	Connector (Host)
	Revised	Current			
USB 1.1			1,5 Mb/s 12 Mb/s	Low Speed Full Speed	Type A
USB 2.0			480 Mb/s	Hi-Speed	Type A
USB 3.0	USB 3.1 Gen 1	USB 3.2 Gen 1	5 Gb/s	SuperSpeed	Type A + C
USB 3.1	USB 3.1 Gen 2	USB 3.2 Gen 2	10 Gb/s	SuperSpeed+	Type A + C
USB 3.2	-	USB 3.2 Gen 2x2	20 Gb/s		Type C
-	USB 3.2 Gen 2x2	USB 4 Gen 2x2	20 Gb/s		Type C
USB 4		USB 4 Gen 3x2	40 Gb/s	Enhanced SuperSpeed	Type C

3.2.7. Other functional parts

Smartphones come with a vibration mechanism and with an increasing number of sensors that provide specific functionalities:

- Accelerometer, which is used by apps to detect the orientation of the device and its movements, as well as allows the phone to react to the shaking of the device (e.g. to change music);
- Gyroscope, which works with the accelerometer to detect the rotation of the device, for features like augmented reality;
- Digital Compass, for map/navigation purposes;
- Ambient Light Sensor, which automatically sets the screen brightness based on the surrounding light, thus helping to reduce the eyes strain and to preserve the battery life;
- Proximity Sensor, which detects the proximity of the device with the body, so that the screen is automatically locked when brought near the ears to prevent unwanted touch commands.

The various sensors are typically miniaturized components. Sensors based on mechanical principles (accelerometer, gyroscope, compass and others) rely on MEMS technology which encompasses mechanical microstructures on silicon substrates. Being mounted on the mainboard appearance of the components is similar to that of other electronics components on the printed circuit board.

Further parts of mobile phones and tablets are loudspeakers and microphones.

3.2.8. Software

Smartphones are run through an Operating System (OS) and firmware. An operating system allows the device to run applications and programs. The firmware is a kind of software that serves for specific purposes related to hardware parts. Updates can determine the performance of essential hardware as battery and CPU; this can determine the overall performance of the smartphone. In this sense, updates as well as a lack of updates can make a smartphone obsolete (Cordella et al. 2020).

Manufacturers provide updates on a regular basis to fix problems and security issues. Updates are as important as the physical elements of a smartphone to ensure a longer life of the device and to reduce phone replacement rates. Security updates, even though do not significantly affect the performance of a device, lead to less secure devices and to potential conditions of obsolescence (e.g. in case of malfunctioning of apps or the risk of data leaks or similar).

Software updates and in particular security updates of operating systems (OS) are crucial for the functionality and data security of a smartphone and tablet.

3.2.8.1. Operating System

The file size of downloading OS versions increased over time, indicating the increasing complexity and functionality. iOS 5.0 released in 2011 had an IPSW file size of roughly 700 MB, iOS 12.0 released in 2018 of roughly 3 GB, and the most recent iOS 14.0 comes with a download file of 4 – 6 GB, depending on the device.

Without security updates devices still work – and are actually used –, but with a risk of data leaks and similar issues. There are significant differences among operating systems and devices for how long such OS security updates are provided. A compilation by Mobile & Security Lab as of March 2019 provides an overview of smartphone models with particularly long OS security update support, and for comparison some other devices (Mobile & SecurityLab 2019): It is apparent that security updates are provided for longer periods, if the device brand is also the developer of the OS, as in the case of Apple and iOS, Nokia/Microsoft in case of Windows, and Google in case of Android (Table 21). iPhones and iOS can be considered BAT in this sense, with the iPhone 5s being supported still today (September 2020)³¹, i.e. 84 months after the release of iPhone 5s. Apple discontinued sales of iPhone 5s in March 2016, which means that even the last units brought on the market see security updates for 54 months by now. Phones by Microsoft, i.e. under the Nokia brand until few years ago, also received Windows security updates for rather long times, exceeding for some models 4 years. Android security updates are provided for significantly shorter periods, 38 months at best for the Google Nexus XS and 6P, and in many cases only 2 years and for some even less than a year.

³¹ <https://support.apple.com/de-lu/guide/iphone/iphe3fa5df43/12.0/ios/12.0>

Table 21 : Availability of Operating System security updates, adapted from (Mobile & SecurityLab 2019)

Brand	Model	OS	Released	regular security update support (months, as of March 2019)	(expected) security update support (years, as of March 2019)	irregular security update support (years)	security update with latest major OS version
Apple	iPhone 5S	iOS	2013	66	6	-	yes
Apple	iPhone 4S	iOS	2011	58	Ended	-	yes
Apple	iPhone 5	iOS	2012	58	Ended	-	yes
Nokia/Microsoft	Lumia 1520	Windows	2013	57	Ended	-	no
Nokia/Microsoft	Lumia Icon	Windows	2014	55	Ended	-	no
Apple	iPhone 6/6 Plus	iOS	2014	54	5+	-	yes
Nokia/Microsoft	Lumia 530/630/930	Windows	2014	50	Ended	-	no
Apple	iPhone 4	iOS	2010	48	Ended	-	yes
Nokia/Microsoft	Lumia 730/830	Windows	2014	47	Ended	-	no
Microsoft	Lumia 640/640 XL	Windows	2015	47	4	-	no
Apple	iPhone 5C	iOS	2013	46	Ended	-	yes
Apple	iPhone 3GS	iOS	2009	45	Ended	4,5	yes
Microsoft	Lumia 430/435/635	Windows	2015	42	Ended	-	no
Apple	iPhone 6S/6S Plus	iOS	2015	42	6+	-	yes
Microsoft	Lumia 950/950 XL	Windows	2015	40	4	-	yes
Microsoft	Lumia 550	Windows	2015	39	4	-	yes
Google	Nexus XS/6P	Android	2015	38	Ended	-	yes
Apple	iPhone 3GS	iOS	2008	37	Ended	-	yes
Microsoft	Lumia 650	Windows	2016	37	3,5	-	yes
Apple	iPhone SE	iOS	2016	36	5,5+	-	yes
Silent Circle	BlackPhone 2	Android	2015	32	Ended	-	no
Apple	iPhone 7/7 Plus	iOS	2016	30	6+	-	yes
Google	Pixel	Android	2016	29	3	-	yes
Fairphone	Fairphone 2	Android	2015	28	3,5+	-	no
Apple	iPhone	iOS	2007	28	Ended	-	yes
Sony	Xperia X	Android	2016	28	Ended	-	yes
Nokia/HMD	Nokia 6	Android	2017	25	2,5+	-	yes
Samsung	Galaxy S6/S6 Edge	Android	2015	24	Ended	2 to 3	no
Motorola	Moto Z	Android	2016	24	Ended	-	yes
LG	G5	Android	2016	23	Ended	-	yes
Blackberry	Priv	Android	2015	23	Ended	-	no
Fairphone	Fairphone 1	Android	2013	20	Ended	-	no
Essential	PH1	Android	2017	18	3	-	yes
OnePlus	OnePlus X	Android	2015	12	Ended	1	no
OnePlus	OnePlus 3	Android	2016	11	3	2,5	yes
Sony	Xperia Z5	Android	2015	<11	Ended	2,5	yes
Huawei	P8	Android	2015	<11	Ended	1 to 2,5	no
Xiaomi	Redmi Note 3	Android	2016	<11	Ended	1 to 2,5	no
Huawei	P9	Android	2016	<11	Ended	1 to 2	no
Samsung	J3	Android	2016	<11	Ended	1 to 2	no
HTC	10	Android	2016	<11	Ended	1 to 1,5	yes

Samsung recently announced that Galaxy smartphones will get OS updates for 3 Android generations, which means an update guarantee for approximately 3 years (Bohn 2020).

The challenges to align Android OS updates with the hardware of a mobile phone has been explained by Fairphone (Derks 2020): Android is released by Google through the Android Open Source Project in the form of source code. The chipset ODM, Qualcomm being in a leading position for Android systems, adapt the source code to their chipset.

The handset OEM builds on the chipset vendor's version of the Android source code. If the chipset vendor does not provide continued support for new OS versions, the chipset simply does not work with following Android generations, and phone vendors typically have to stop support of newer OS versions. As demonstrated by Fairphone in case of the Fairphone 2 and Android 7 it is not impossible to make a device compatible with newer OS versions, even without the support of the chipset vendor, but only with some major limitations. Fairphone went through this process once again for Android 9, thus demonstrating that continued OS maintenance is feasible. The Fairphone 2 was released in December 2015, which means as of September 2020 an OS update support of 57 months, which is similar to iPhone models released since 2014.

iPhones are typically compatible with the latest iOS version for 5 to 6 years from release of a given model (Feurer 2020).

Sometimes OS upgrades do not lead to the expected performance improvement but can slow down a device³², limiting its functionality. In these cases the best option might be to downgrade back to the former OS version. Frequently, such an option is not supported by OS and phone providers.

3.2.8.2. Apps

There are examples of "lighter" app versions developed by the app provider, e.g. Messenger Lite: an alternative to Facebook client, which takes up much less space than the standard version, occupying less than 10 megabytes. This makes it lighter, which means it can run without any problems on older devices with previous versions of Android.

3.2.8.3. Serialisation

Software locking or serialisation refers to the practice of matching the serial number of specific components to the device. When a damaged component is replaced by a component with a different serial number, software may lock the new component from performing its function or trigger messages on the device to inform about possible malfunction, unless integrity of the component is confirmed. Dedicated software is required to calibrate the new component to the device, and is typically only available to authorised repairers nowadays. This practice is witnessed in other product categories beside smartphones, but it is becoming more common, as more manufacturers resort to it and apply it to a wider range of components, according to a statement made by stakeholders ECOS, Coolproducts, Right to Repair, EEB, and iFixit, but also confirmed by other sources (O'Rangers 2020; MacRumors Forums 2021). Pairing a new component with a repaired device typically first requires authorized confirmation from the device owner, that a repair is intended as otherwise lost or stolen devices might be unlocked without the owner's consent.

Serialization is used primarily on security-related components such as fingerprint sensors and cameras that enable facial recognition to prevent unauthorized unlocking of devices and access to private data. It is also used on batteries to verify the use of an OEM part for safety purposes: Since not all batteries are charged at the same voltage, using third-party batteries could lead to safety issues. Similarly, facial recognition functions of camera modules require calibration, otherwise the light projector built into the module could become a safety issue. Serialization is also used in these cases to ensure that neither the battery management hardware and software nor the memory in which the

³² see <https://benchmarks.ul.com/news/is-it-true-that-iphones-get-slower-over-time?redirected=true#>; UL "benchmarking data shows that, rather than intentionally degrading the performance of older models, Apple actually does a good job of supporting its older devices with regular updates that maintain a consistent level of performance across iOS versions."

light projector's calibration data is stored are tampered with by third parties. Serialization is also applied to prevent off spec rejects from the OEM's supply chain from becoming spare parts. Although such software locks can have a significant impact on repairability for third parties and on the reuse of components from used equipment without the OEM's consent, it has to be acknowledged that component integrity testing has significant safety and security benefits for the user.

3.2.9. Chargers

External power supplies provided with mobile phones and tablets are typically not of the same power rating, although there are overlaps of the rating range (Table 22). Values in the table below are those from the impact assessment study under the common chargers initiative (Ipsos, Trinomics, Fraunhofer FOKUS, Economisti Associati 2019), whereas Xiaomi in a stakeholder comment stated significantly higher values as a recent trend.

Table 22 : Comparison of charger specifications for tablets and smartphones

	Current		Voltage		Power		source
	Max	Min	Max	Min	Max	Min	
Smartphones	2,5A	1A	12V	5V	18W	5W	Ipsos et al.
	6,2A	2A	20V	5V	120W	10W	Xiaomi
Tablets	3,25A	1A	20V	3,76V	65W	9,36W	Ipsos et al.

Chargers for tablets are typically rated for a higher wattage, occasionally being in the same range as laptop computers (65W).

3.2.10. Accessories

A smartphone can include a set of accessories in the sale package:

- Headset;
- Data transfer cable;
- External Power Supply (charger);

Nowadays, the external power supply (EPS) is most of the time detachable from the charging cable and most smartphones on the market use technologies based on USB specifications and standards. USB Type-C connectors have been gradually replacing older USB connectors for most Android OS smartphones (>75 % of the market). An alternative proprietary solution is e.g. Lightning by Apple.

The impact assessment study on common chargers of portable devices that was conducted for DG GROW in 2019 concluded that there is no clear-cut "optimal" solution (European Commission 2019). However, the study also points out that consumer's convenience could be improved by pursuing common connectors in combination with interoperable EPS.

Today, more and more phones are also equipped with wireless charging and power share features. This provides further charging options to consumers and reduces the mechanical strain put on the USB connector throughout the phones lifetime. However, when it comes to charging efficiency, it has been shown that the efficiency can be lower by approximately 24% on average when compared to wired charging, but that there are also rather efficient combinations of wireless charger and handset, which are similar energy efficient as wired charging (Sánchez et al. 2018). Energy efficiency is a complex issue, which requires a system approach addressing both, the transmitter and the receiver side of the system and thus cannot be addressed by the handsets alone. The

main issue is that the transmitter (wireless charger) side should enable optimal alignment and coupling with the handset. Allowing for a universal use of wireless chargers however contradicts partly the intention to optimise energy efficiency of power transmission. Regarding interoperability there is currently another study in progress for DG GROW, which investigates the technology and market status of wireless charging.

Others accessories rarely sold by the OEM together with the handset include:

- Micro SD cards (these can extend the memory capacity, but due to data transfer limitations cannot perform as seamless as on-board memory);
- Protection accessories: protective cases (also called bumpers) and screen protectors.

SIM cards are another kind of accessory, provided by a network operator. Form factor variants are mini-SIM, micro-SIM and nano-SIM, and eSIM (embedded SIM), which is a specific integrated circuit on the mainboard.

The accessories are typically placed in the sales package underneath the smartphone. Figure 65 depicts this assembly of charger, USB cable and headphones in a cardboard box, with the smartphone and manual removed. These accessories typically absorb half of the package volume.



Figure 65 : Accessories in a smartphone packaging

3.3. BAT – Best Available Technology at product level

3.3.1. Mobile phones

3.3.1.1. Energy efficiency

Energy consumption of mobile phones is a very complex issue as it relates to hardware and software. As such, reducing energy consumption is essential for mobile phone developers to increase battery lifetime in terms of hours in standby or active (benchmark) use, which is a major performance feature for mobile phones and also tablet computers.

Technical measures to increase energy efficiency are manifold and listed in detail by Pramanik. Some of these measures, which can partly be assumed to be implemented already (BAT), and partly originate from ongoing research (BNAT) are (Pramanik et al. 2019):

- various power management options,
- data compression for faster data exchange,
- adapted WiFi sensing,
- frame rate adjustment to use patterns,
- sharing of location-sensing data across applications,
- parallelism across multi-core processors,
- dynamic setting of voltage, CPU frequency and memory bandwidth
- brightness adaptation
- energy-optimised design of applications, though being rather a third party issue

The smartphone with the by far best battery endurance rating, indicating a particular good energy efficiency, by GSMArena is the low-end device Realme 6i with an above-average 5000 mAh battery. Further specifications of this device are a Mediatek Helio G80 (12 nm, Octa-core) CPU, 6,5" LCD with 1.600 x 720 pixel, 2G / 3G / 4G connectivity, WiFi, Bluetooth. This device is tested with a battery endurance of 35 hours talk time, 30 hours web browsing, or 21 hours video playback, or 186 hours with 1 hour talk time, web browsing, video playback each per day³³.

3.3.1.2. Overall weight

In terms of minimum weight, i.e. material use, the Zanco Tiny T1 with only 13 g, and a size of 47 by 21 millimetres³⁴, is Best Available Technology for mobile voice communication, but with a very limited user experience. Hence, this mobile phone cannot be considered as BAT for the mobile phone market as such, and rather serves as an illustration, how much material is needed at best for the mobile voice communication functionality.

3.3.1.3. Use of recycled material

The use of recycled material in mobile phones has increased in past years. Whereas several metals sourced on the global market typically are a mix of primary and secondary material anyway, such as copper, ferro metals, and precious metals, there are other metals, where sourcing recycled material is much less common. Examples claimed by OEMs are stated in Table 23. Further details regarding the origin of the secondary raw materials are stated in the environmental reports of the referenced OEMs.

³³ Test conditions : https://www.gsmarena.com/gsmarena_lab_tests-review-751p6.php

³⁴ <https://www.telecom-handel.de/distribution/h-o-t-phone/hotphone-bringt-bonsai-handy-deutschland-1657765.html>

Table 23 : Recycled material in smartphones (Apple Inc. 2020; Google 2020a; Samsung 2020; Fairphone 2020; Umicore 2020; Fairphone 2018; Apple 2020b)

Material	Post-industrial (PIR) or post-consumer (PCR) recycled share	Application	Reference
Neodymium and possibly Dysprosium	100%, unknown if PIR or PCR	Taptic Engine of iPhone 11, iPhone 11 Pro, and iPhone 11 Pro Max	Apple
Rare earth elements	100%, unknown if PIR or PCR	all magnets in iPhone 12 (and MagSafe accessories)	Apple
Tin	100% PCR	solder on main logic boards of iPhone XR, iPhone 11, iPhone 11 Pro, iPhone 11 Pro Max, iPhone SE (2020)	Apple
Aluminum	unknown ³⁵	aluminum enclosures for iPhones released 2019	Apple
Cobalt	Unknown share, PCR	Battery for “portable electronics”	Umicore
Tungsten	50%, unknown if PIR or PCR	Vibration motor Fairphone 2	Fairphone
Plastics	35%, unknown if PIR or PCR	multiple components of iPhone 11 Pro Max	Apple
	35% PCR	iPhone XR speaker enclosure	Apple
	47% PCR	plastic mechanical parts of Google Pixel 4a	Google
	20%, unknown if PIR or PCR	Power supply Galaxy Note 9	Samsung
	40%, unknown if PIR or PCR	Plastic parts of Fairphone 3+	Fairphone
Polycarbonate	50% PCR	back covers and modules Fairphone 2	Fairphone

There are other product examples dating back several years, where recycled plastics in significant amounts has been used. In general an increased share of recyclates, metals and polymers, beyond die general primary-secondary mix of some bulk metals is increasingly popular among some manufacturers.

3.3.1.4. Use of bio-based polymers

Few manufacturers use bio-based polymers for some selected parts. The term ‘bio-based’ means that the material or product is (partly) derived from biomass (plants). Biomass used for bioplastics stems from e.g. corn, sugarcane, or cellulose (European Bioplastics).

Table 24 : Biobased material in smartphones (Apple Inc. 2020; Google 2020a; Samsung 2020; Fairphone 2020; Umicore 2020; Fairphone 2018)

Material	Bio-based content	Application	Reference
Bio-based plastics	32%	Cover glass frame iPhone XR	Apple
	37%	Front Deco Part Galaxy S10	Samsung
	29%	Earjack Galaxy S10	Samsung

³⁵ As Apple’s environmental report states “either 100 percent recycled or low-carbon primary aluminum”

"Bio Nylon"	unknown	"Bio Nylon" in Earjack Galaxy Note9	Samsung
-------------	---------	-------------------------------------	---------

3.3.1.5. Robustness

There are rugged mobile phones which are tested against numerous durability criteria, such as the Samsung Galaxy XCover Pro smartphone, which is IP68 rated and has passed 21 criteria of MIL-STD-810G according to Samsung (see Task 1 report). Furthermore it also features a removable battery and the display assembly is fairly easy to replace, with a moderate level of repair experience. The display assembly is fixed with adhesives to the frame, which can be separated by applying moderate heat and with prying tools. The connector cable from display to mainboard is in the center of the display assembly minimising the risk to rip off or cut the cable at repair.

Such devices come with a rubber shell, bumpers or similar protective design features, which adds to weight and size compared to "regular" mobile phones.

In 2018 Samsung announced a flexible OLED panel with an "unbreakable" substrate and an overlay plastic window securely adhered to it³⁶. Such a technology could reduce display defects caused by accidental drops, but there is no public information that this display made it into any product on the market yet.

3.3.1.6. Removable battery

The last flagship smartphone featuring a removable battery *and* a high IP class of IP67 has been the Samsung Galaxy S5 (market introduction 2014). The plastic backside cover is removable. A rubber seal on the inside of the back cover protects the battery from water and dust ingress (Figure 66). An argument against removable batteries is frequently the thickness of the device as these batteries require additional casings compared to integrated pouch cells and also larger contact pads. The Galaxy S5 however is only 8,1 mm thick, which is similar to many more recent smartphone models – at a battery capacity of 2.800 mAh, which was above average in 2014, but is nowadays well below the average of even the low-end segment of mobile phones (see Figure 15, p. 27).

³⁶ <https://news.samsung.com/us/samsung-displays-unbreakable-panel-certified-underwriters-laboratories/>



Figure 66 : Samsung Galaxy S5, backside cover removed

Among feature phones removable batteries are still common, but usually without the high IP rating. There are however some rugged feature phones, such as the Caterpillar B30 with a removable battery and IP67 rating (at a device thickness of 16 mm).

3.3.1.7. Battery integration with stretch-release tapes

For integrated batteries stretch-release tapes with pull tabs are suitable to remove batteries easily and without applying excessive force to the battery. It is however best to pull the adhesive strip in an angle as flat as possible. Typically other components or the frame require pulling in non-optimal directions for a smooth removal of the battery (Figure 67).

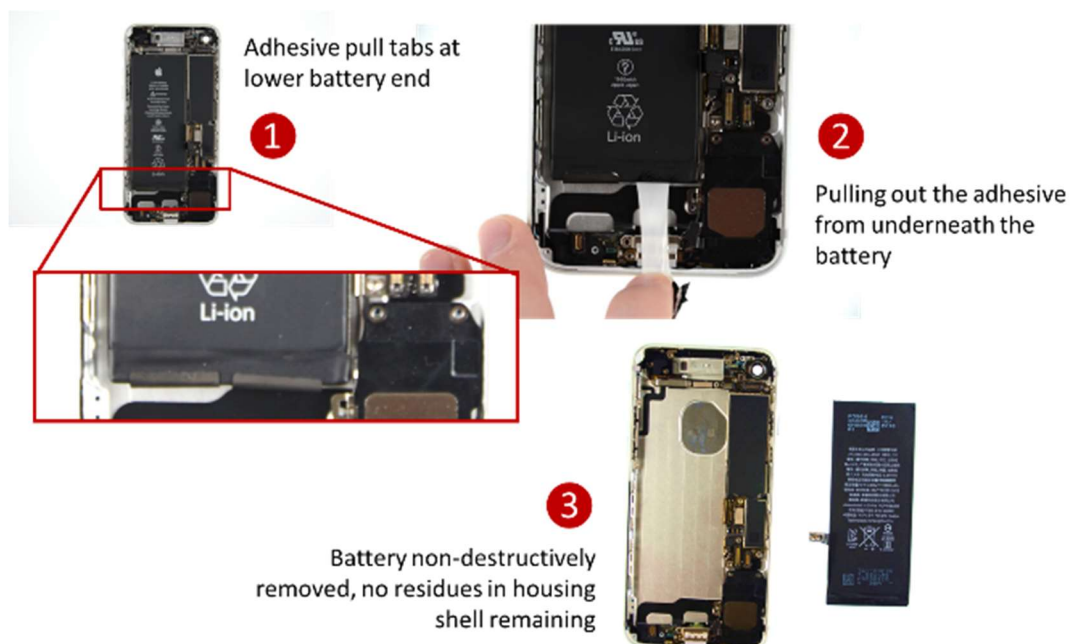

Figure 67 : Battery with pull-tab adhesive strips

The best design in terms of pull tabs is apparently the Google Pixel 4a, where little windows in the midframe on which the battery is mounted allow for a backside access to

the battery and pull tabs are provided here and can be pulled at an angle of nearly 0° (Dixon 2020). Such a design however is only feasible where the battery is mounted on a mid-frame, not where it is attached to the back cover.

3.3.1.8. Modularity

A modular design can significantly simplify repair of smartphones. Fairphone and Shift both encourage users to undertake repairs by exchanging defect components of the phone. The modules of the Fairphone 3 and 3+, which are available as spare parts and can be replaced by the user, are:

- Rear camera (in two variants)
- Battery
- Display
- Top module (front camera and audio; in 2 variants)
- Bottom module (vibration motor, USB-C connector and primary microphone)
- Speaker module
- Back cover

The core module with the main processor, RAM, memory and radio chipsets is not provided as a spare part by Fairphone.

Shift provides as spare parts for their smartphones batteries and displays, but currently none of the other modules through their online shop. Shift ships their module smartphones with a Torx T3 screw driver.

In the reparability rating by iFixit the Fairphones 2 and 3 reached a 10 out of 10, followed by the Shift 6m with a 9 out of 10³⁷ (Table 25). All other similarly high rated smartphones by iFixit have been launched 7 to 9 years ago and do not represent current product generations. For changes in scores over time see Task 1.

Table 25 : Reparability assessment of best scoring smartphones by iFixit

Device	Fairphone 2	Fairphone 3	Shift 6m
Assessment by iFixit	<ul style="list-style-type: none"> • The most commonly failing components, battery and display, can be replaced without tools. • Internal modules are secured with Phillips #0 screws and simple spring connectors. • Individual modules can be opened, and many components can be individually replaced. 	<ul style="list-style-type: none"> • Key components like the battery and screen have been prioritized in the design and are accessible either without tools or just a regular Phillips screwdriver. • Visual cues inside the phone help with disassembling and replacing its parts and modules. • Replacing complete modules is very easy. Going for their internal parts is also possible and requires a Torx screwdriver. 	<ul style="list-style-type: none"> • Battery and screen repairs are prioritized. • Only one type of screw head and length are used throughout the phone. • The manufacturer provides a few repair guides, and a screwdriver is shipped with the phone.

³⁷ https://www.ifixit.com/smartphone_repairability?sort=score

Other manufacturers follow a strategy of a more internal modularity, which allows replacement of parts and components, but typically only by professional repair staff. An indicator of this increasing internal modularity is the number of connectors on the logic board, each connecting to another part or module of the device (Figure 68).

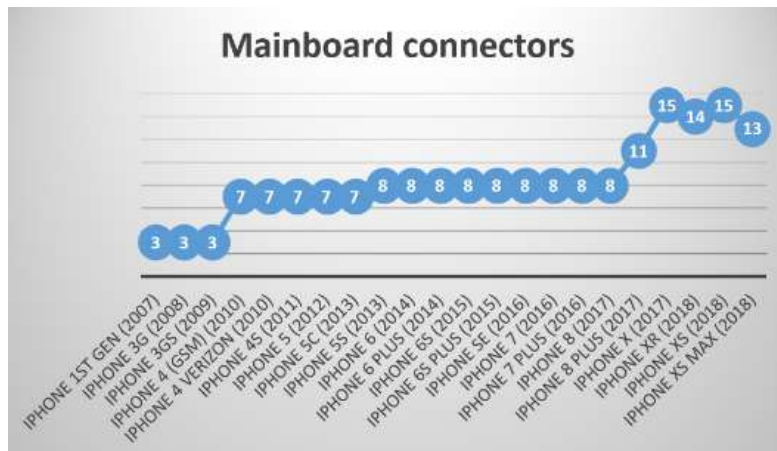

Figure 68 : Amount of connectors on logic boards of iPhones, 2007-2018 (Schischke et al. 2019)

3.3.1.9. Cross model and backwards parts compatibility

If same sub-assemblies are used for different mobile phone models this reduces spare parts variety, can enhance spare parts availability in general and through cannibalisation of defect devices. Furthermore, manufacturing of the sub-assemblies is likely to have a smaller environmental footprint as the ramp up phase for producing new model components is omitted and sub-assembly designs, which already have been tested in the field, make it into new products, so failure rates are likely to be lower.

An example of such a cross-compatibility of parts are the iPhone SE (2020) which shares several sub-assemblies with the iPhone 8 (market introduction 2017): the cameras, SIM tray, Taptic Engine, and display assembly (including the microphone and proximity sensor) are all swappable with iPhone 8 parts. Despite a similar size the batteries are not cross-compatible due to different connectors (Webb 2020).

It is assumed that similar cross-compatibility is – accidentally - given for other smartphone models as well as sub-assemblies are partly sourced from same suppliers, such as cameras or loudspeakers.

3.3.1.10. Memory capacity variants of the same model and memory extension cards

Some brands offer the same mobile phone model with memory capacity variants. As flash memory represents a significant share of the environmental footprint, offering the same model with different memory variants leaves it to the user to choose the most appropriate memory configuration. As memory has a significant influence on price, there is a clear cost incentive to choose a rather low memory specification, which means a smaller environmental footprint of the device. This product policy might also have the adverse effect, that users underestimate the need of memory capacity and exchange devices more rapidly – but this might be the case for only one given memory configuration as well.

Several manufacturers implemented such a product policy to offer more than one memory configuration for a given model. This is the case at least for all Apple iPhones, OnePlus, Xiaomi, Realme, and some Huawei phones.

Low-end phones usually do not come with memory capacity variants, but allow for memory extension through microSD, microSDHC, or microSDXC memory cards, which is also the case for some flagship phones, which do not otherwise provide memory capacity variants, such as the Samsung Galaxy S20 with a memory extension of up to 1 TB. The advantage of a memory card extension is the simple use of this card to following smartphones, given the same card format is supported.

3.3.1.11. Unbundling

Very few mobile phones can be ordered without a power supply unit. Examples are the Fairphone 3 / Fairphone 3+ and SHIFT5me and SHIFT6m. Existing compatible power supplies can be used further with these smartphones.

In October 2020 Apple announced to ship iPhones without charger and headset ("EarPods"), and just to keep the USB-C to Lightning cable in the shipping box. This measure allows Apple also to reduce the package size, and Apple claims now to ship 70% more phones on a pallet and correlates this with massive carbon savings (Apple 2020b). Later on also Samsung announced to ship the Galaxy S21 without a charger in the box (Phone Arena 2021).

3.3.1.12. EPEAT rating

Statistics of EPEAT criteria (see Task 1 report) met by mobile phones indicate, which product related features are broadly implemented already and which ones are apparently more challenging. The analysis provided in Figure 69 shows that for none of the registered products a removable battery is claimed. Next "most challenging" criteria, which are however met by several models include:

- Substitutions assessment
- Receiving substance inventory
- Post-consumer recycled plastic and biobased plastic content in the mobile phone
- Post-consumer recycled plastic and biobased plastic content in accessories
- Improve packaging efficiency
- Product LCA third-party verification or making LCA publicly available
- Reduce fluorinated gas emissions from flat panel display manufacturing

The highest EPEAT score is currently reached by the iPhone Xr, with 103 points out of 119.

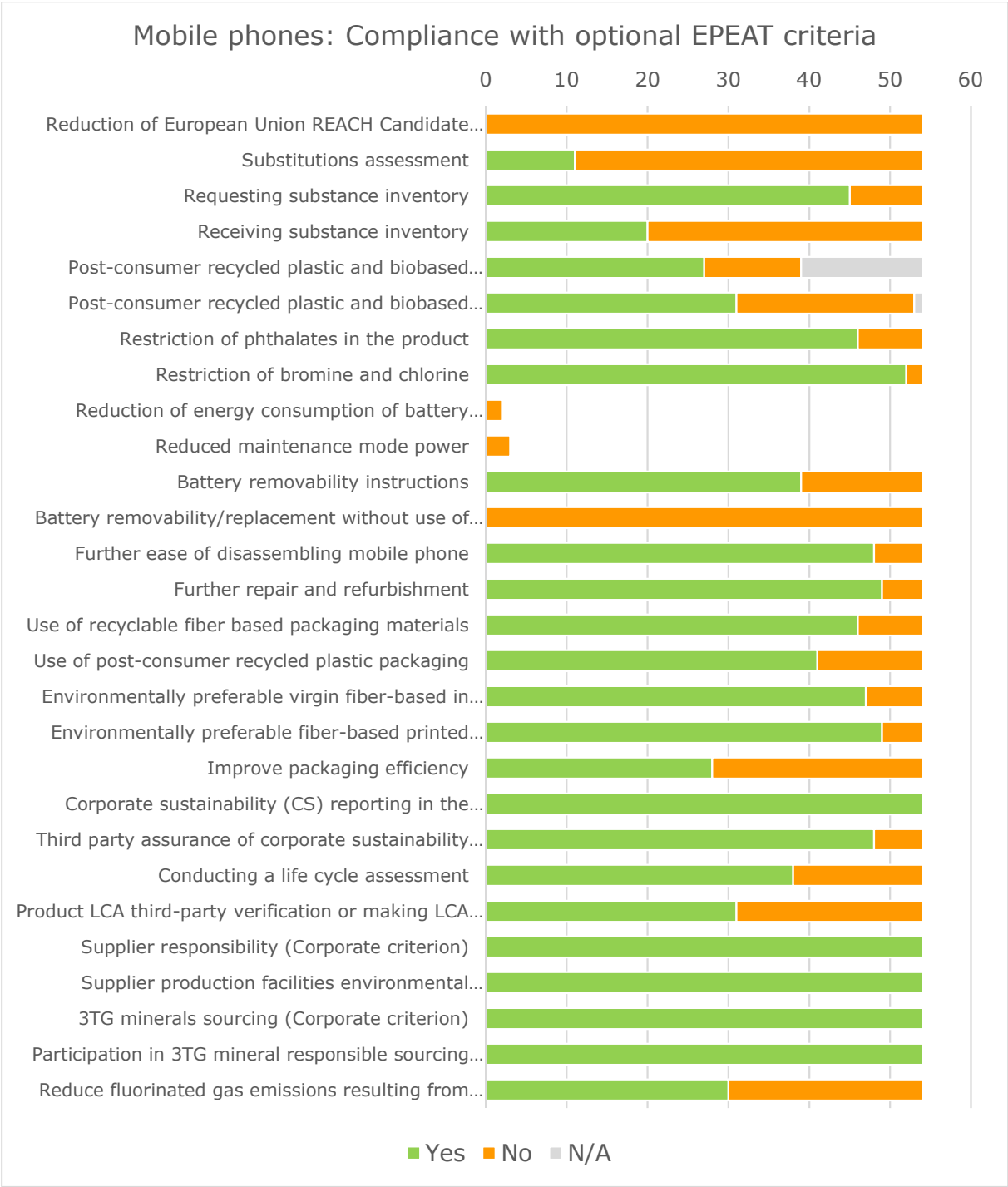

Figure 69 : Compliance of EPEAT-registered mobile phones with optional criteria (active products as of June 17, 2020)

3.3.2. Tablet

3.3.2.1. Overall weight

The most light-weight tablet on the market is the 7-inch Android tablet Alldocube iPlay 7T with a weight of only 224 g. Features are those of an entry-level tablet with a 0.3MP front camera, 2MP rear camera, mono speaker, built-in 4G LTE (for some but not all regions) with GPS, 2.4 GHz 802.11 b/g/n Wi-Fi, Bluetooth 4.0, a USB C port, a 3.5mm

audio combo jack, and a 2800 mAh battery³⁸. This example serves as an illustration, how much material is needed at best for general tablet functionality.

3.3.2.2. Use of recycled material

Examples of recycled materials used in tablets and claimed by OEMs are stated in Table 26. In general, recycled materials stated for smartphones in 3.3.1.3 are also an option and might be in use already for tablets. In particular the use of recycled plastics is a mandatory and an optional criteria of EPEAT which is claimed for some tablets, but without giving any further details, which parts and polymers this might refer to.

Table 26 : Recycled material in tablets (Apple Inc. 2020; Google 2020a; Samsung 2020; Fairphone 2020; Umicore 2020; Fairphone 2018)

Material	PIR or PCR and recycled share	Application	Reference
Neodymium and possibly Dysprosium	100%, unknown if PIR or PCR	loudspeakers of iPad Air (2020) ³⁹	Apple
Tin	100% PCR	solder on main logic boards of iPad (7th generation)	Apple
Aluminum	unknown ⁴⁰	aluminum enclosures for iPads released 2019	Apple
	100%, unknown if PIR or PCR	aluminum enclosure for iPad Air 2020	Apple
Cobalt	Unknown share, PCR	Battery for “portable electronics”	Umicore

3.3.2.3. Use of bio-based materials

There is no known use of bio-based plastics for tablet computers. Applications of bio-based plastics for smartphone parts as listed in 3.3.1.4 indicate the feasibility of bio-based polymers for mobile devices.

MicroPro Computers developed a fully functional Windows tablet computer with a wooden housing, demonstrating the feasibility of using wood for tablets (backcover with cavities for various subassemblies, battery cover, and buttons) (Ospina et al. 2019).

³⁸ <https://tabletmonkeys.com/7-inch-android-9-0-tablet-alldocube-iplay-7t-launch/>

³⁹ Apple Event, September 15, 2020, at 10 a.m. PDT, Apple Park, and <https://www.apple.com/ipad-air/> (accessed September 15, 2020)

⁴⁰ As Apple’s environmental report states “either 100 percent recycled or low-carbon primary aluminum”



Figure 70 : Wooden parts of the D4R iameco tablet, Kappa prototype (Maher et al. 2018)

3.3.2.4. Robustness

There are rugged tablets which are designed for professional outdoor use, industrial use, and also several business tablets are designed for durability, not for minimal form factors. Rugged tablets are specified for drops (up to 180cm), extended temperature ranges from e.g. -20°C to 60°C, and elevated humidity⁴¹. Shock resistant design is achieved typically through a rubber case or rubber bumpers. IP class 67 is also found as a specification for some designs. Also some tablets made for children feature a particular robust design and withstand rough handling.

3.3.2.5. Removable battery

There have been few tablet computers with a removable battery in the past, such as the Dell Latitude 10, the latter being introduced in the market in 2012.

⁴¹ <https://www.it-zoom.de/trend/rugged-tablets/>

3.3.2.6. Battery integration with screwed battery frames

There are integrated batteries in some tablet computers, such as Samsung’s Galaxy Tab, where the battery comes with a frame and screw holes. Once the device is opened and connectors released, batteries can be unscrewed easily⁴². Such a design is not known from smartphones.

3.3.2.7. Reparability

In the reparability rating by iFixit the HP Elite x2 introduced in 2016 reached a 10 out of 10. Several other tablets by HP and a 2013 tablet by Dell reached 9 out of 10 (Table 27).

Table 27 : Reparability assessment of best scoring tablets by iFixit

Device	HP Elite x2	HP Elite x2 G4	HP Elite x2 1012 G2
Assessment by iFixit	<ul style="list-style-type: none"> • Easy opening procedure. • Simple, modular, glue-free design. • Manufacturer-provided repair documentation. 	<ul style="list-style-type: none"> • All screws are standard Torx or Phillips—only three drivers are needed for complete disassembly. • Easy access to repair documentation and replacement parts by HP makes self-repair more feasible. • A modular and flat construction allows access to most components early on. 	<ul style="list-style-type: none"> • All screws are standard T5 Torx, Phillips #1, or Phillips #0. • Manufacturer provided repair documentation takes the guesswork out of repair. • Removing the battery, display, and system board is relatively straightforward and does not require fighting against adhesive
Device	HP Elite X2 1013 G3	HP Pro x2 612 G2	Dell XPS 10
Assessment by iFixit	<ul style="list-style-type: none"> • All screws are standard Torx or Phillips. • Easy access to repair documentation and replacement parts by HP makes self-repair more feasible. • A modular and flat construction allows access to most components, <i>but layering issues and excessive adhesive make the process less straightforward.</i> 	<ul style="list-style-type: none"> • Manufacturer-provided repair documentation. • Easy opening procedure. • Intricate construction allows for modularity <i>but makes repair more complex than necessary.</i> 	<ul style="list-style-type: none"> • Easy to open. Easy to remove battery. • Color-coded screws and labeled cables inside. • <i>LCD is fused to the glass.</i>

⁴² <https://www.wikihow.com/Take-the-Battery-Out-of-a-Samsung-Galaxy-Tablet>

3.3.2.8. Memory capacity variants of the same model and memory extension cards

Just as with smartphones, some brands offer the same tablet model with memory capacity variants, see 3.3.1.10. Several manufacturers implemented such a product policy to offer more than one memory configuration for a given model, such as Apple for its iPads. Others, in particular entry level devices allow for memory extension through microSD, microSDHC, or microSDXC memory cards.

3.3.2.9. Unbundling

Among tablet brands there is no known case of unbundling, where a tablet is provided optionally without an external power supply.

3.3.2.10. EPEAT rating

An analysis of the EPEAT registry for tablets / slates gives some indications, which of the criteria defined in IEEE 1680.1 are easier to meet than others, and which ones are not claimed at all yet by registered products. Figure 71 depicts an analysis of all active tablets / slates in the EPEAT registry, indicating the share of devices complying with the optional criteria⁴³.

56% of the registered products meet the criterion 4.8.1.1 on life cycle assessment (LCA). However, this LCA does not need to cover the registered product, but any one of its products covered under the scope of this standard – which could be computers others than tablets or displays -, at least every three years using ISO 14044 and ISO 14040. A product specific carbon footprint assessment (criterion 4.8.1.2) applies only to 27% of registered models.

Only few products meet the optional criteria publicly available service information (4.4.2.2) and on upgradeability and reparability (4.4.2.5), both with a share of 9% of all registered products. IEEE 1680.1 lists several hardware features, which can be subject to repairs or upgrades and meeting this requirement requires that a minimum number of hardware features are upgradeable, repairable or replaceable without soldering or de-soldering and using only commonly available tools and / or a minimum number of hardware features for which the manufacturer, authorized service providers or other service providers offer upgrades, repair or replacement to purchasers for 5 years after the point of sale.

⁴³ Analysis based on registered products as of June 17, 2020; models with the same model name registered in several countries are counted only once (n = 78)

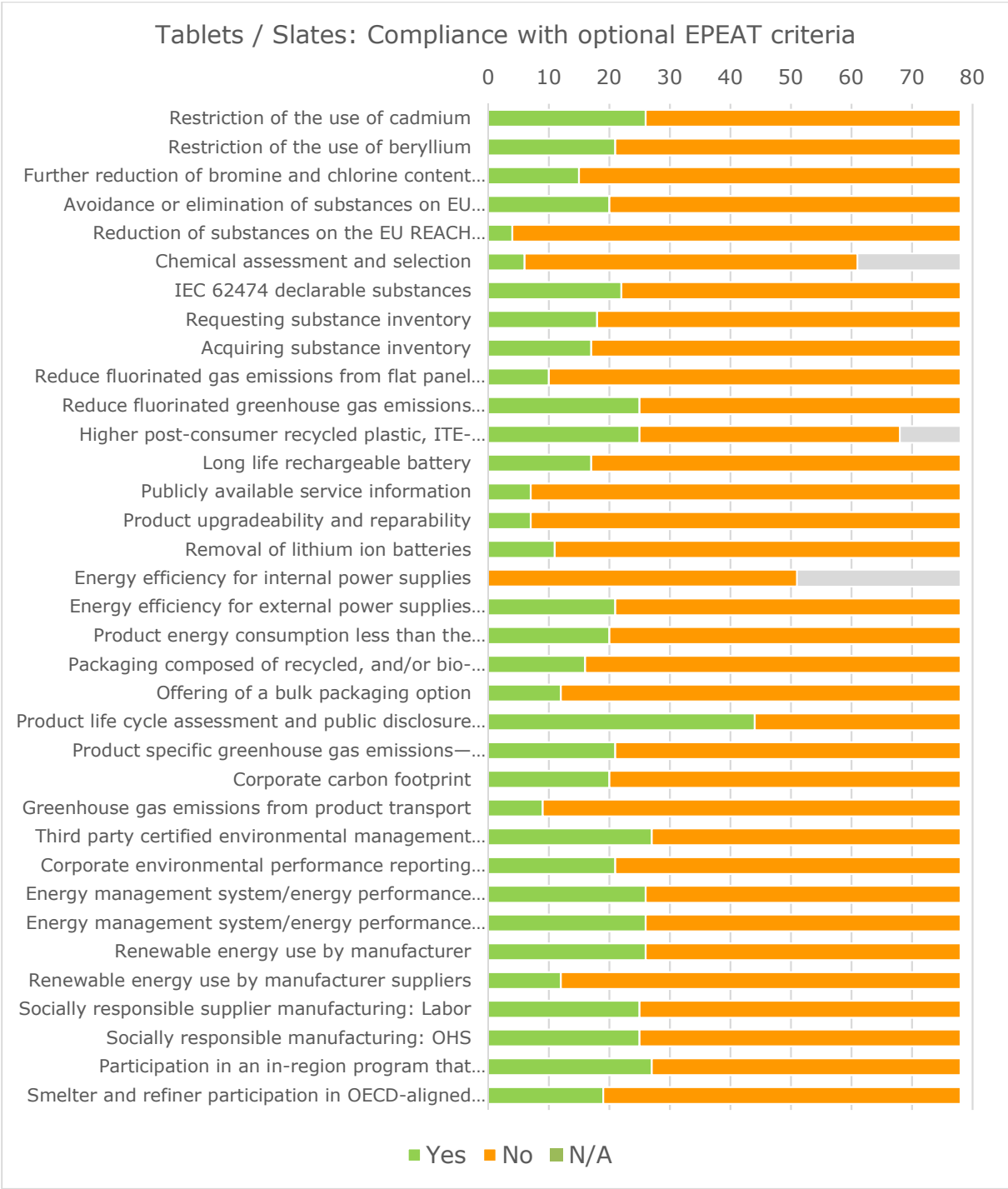

Figure 71 : Compliance of EPEAT-registered Tablets / Slates with optional criteria (active products as of June 17, 2020)

A higher post-consumer recycled plastic, ITE-derived post-consumer recycled plastic, or bio-based plastic content (4.2.1.2) is claimed by a larger number of devices (32%): For 11 models a content of at least 3% is stated, for a another 14 models minimum 5%. It has to be noted however, that a content of 2% is anyway a required criterion (4.2.1.1) and has to be met by all registered devices.

Measures to reduce fluorinated gas emissions from flat panel display manufacturing (4.1.10.1, 13%) are much less frequently claimed than measures to reduce fluorinated greenhouse gas emissions from semiconductor production (4.1.10.2, 32%): To meet these requirements fluorinated greenhouse gases have to be reduced by 90% in the case

of display manufacturing (75% of the suppliers), and by 70 or 75%⁴⁴ for 300 mm semiconductor fabs in the other case (75% of the suppliers).

22% of registered tablets / slates claim to meet the criterion of a long life rechargeable battery (4.4.1.2), i.e., > 65% of the original design capacity after 1000 cycles.

The highest EPEAT score is currently reached by the Apple 11-inch iPad Pro, Apple 12.9-inch iPad Pro, Dell Latitude 7210 2-in-1, and Lenovo ThinkPad X1 Tablet Gen 3 all with 39 points out of 49.

3.3.3. Cordless phones

BAT values are listed below, reflecting the best values found by Stiftung Warentest on the German market (see statistics in 3.1.3) and further product examples.

Table 28 : DECT phone BAT values

Parameter	BAT	Remarks
standby power DECT phones with base station	0,4 W	
standby power DECT phones with charging cradle only	< 0,05 W	Additional power consumption of the (third-party) router
phone time with fully charged battery	37 hours	
standby duration with one full battery charge, standard settings of the base station	18,5 days	
standby duration with one full battery charge, eco settings of the base station	17,5 days	long standby time might be achieved through less effective eco settings, no further information available
low radiation feature and adjustable transmission power of the base station, and compatible with handset	yes	this feature is common for (almost) all products on the market
standard batteries	yes	rather a typical feature of DECT phones
ingress protection	IP65	example: Gigaset R650H PRO, with replaceable standard AAA batteries

Removable batteries, and even the use of third party standard AAA batteries are typically used in cordless phones. In general, due to the lower complexity of cordless phones they feature many characteristics, which are BAT for smartphones, such as larger mono-material parts in the housing and fasteners, which are rather easy to open. With a basic level of technical understanding cordless phones usually can be opened and all major parts disassembled.

3.4. BAT – Best Available Technology at component level

“Best-performing Available products and Technologies” (BAT) are defined as the point that gives the highest possible environmental benefit in absolute terms (Kemna et al. 2005). As mobile phones and tablets are complex systems, “best-performing” can actually only be judged in the system context. Given these limitations the following

⁴⁴ Depending on whether fluorinated heat transfer fluids are included in the assessment or not.

chapters indicate some technologies on the product level, which can be considered to be of a relevant environmental benefit.

3.4.1. Battery

The smartphone with the largest battery capacity currently on the market (1s1p battery design) is the Samsung Galaxy M51 released in September 2020, with a rated capacity of 7.000 mAh. Tablets feature also larger batteries. Large battery capacities can be considered BAT as this reduces the charging frequency, i.e. is better for overall battery health and lifetime.

For cordless phones the widespread use of standard AAA NiMH batteries constitutes Best Available Technology as it allows to use widely available batteries as a replacement. Long battery life is important to reduce the environmental impact of battery replacement as such, but is not much of a limiting factor for the whole device.

Field data as presented in 3.2.3.4 indicates that Li-ion smartphone batteries can last for more than 1.000 cycles (@ minimum 80% remaining capacity) and tablet batteries for more than 500 cycles, the latter rather being a result of missing field data, not as an indication that lifetime of tablet batteries is shorter. Actually, there is no technical reason, why tablet batteries should not last as long as smartphone batteries.

3.4.2. Cover and backside glass

Specific hardened glass enhances overall robustness of mobile phones and tablets. Market leader for special glass for smartphones and tablets is Corning. Their latest glass generation Corning® Gorilla® Glass Victus™ is claimed to be more robust than prior glass generations and to provide better drop resistance than competitive aluminosilicate (Corning 2020c; Barrett 2020). The specification and technical parameters of Corning Glass is provided in Table 29: Regarding the robustness of the glass it is important to understand, that not only the glass properties matter for overall device robustness, but also the way the glass is integrated in the device.

Table 29 : Specification of Corning Glass generations 5, 6, and 7 (Corning 2020b, 2020a, 2020c)

Parameter	Corning® Gorilla® Glass 5	Corning® Gorilla® Glass 6	Corning® Gorilla® Glass Victus™
Standard thickness	0,4 – 1,2 mm	0,4 – 0,9 mm	0,4 – 1,2 mm
Density	2,43 g/cm ³	2,40 g/cm ³	2,40 g/cm ³
Young's Modulus	77 GPa	77 GPa	77 GPa
Poisson's Ratio	0,21	0,21	0,22
Shear Modulus	31,7 GPa	31,9 GPa	31,4 GPa
Vickers Hardness (200g load)			
unstrengthened	559 kgf/mm ²	611 kgf/mm ²	590 kgf/mm ²
strengthened	608 kgf/mm ²	678 kgf/mm ²	651 kgf/mm ²
Fracture toughness	0,69 MPa m ^{0,5}	0,70 MPa m ^{0,5}	0,76 MPa m ^{0,5}
Coefficient of expansion (0-300°C)	78,8 x 10 ⁻⁷ /°C	75,2 x 10 ⁻⁷ /°C	75,2 x 10 ⁻⁷ /°C

Samsung Note 20 uses Corning® Gorilla® Glass Victus™ as front cover. The prior generation 6 has been used by Samsung not only for the display cover glass, but also for the backside, which is similarly important for overall drop resistance (SamMobile 2020).

With the iPhone 12 Apple introduced a new display cover glass, integrating "nano-ceramic crystals" in the glass, and claiming a significantly enhanced robustness of the

glass⁴⁵, but without providing any further material data. The glass is produced by Corning (Vincent 2020).

3.4.3. Parts with recycled or bio-based materials

Individual components made with recycled or bio-based materials are already listed in chapters 3.3.1.3, 3.3.1.4, 3.3.2.2, and 3.3.2.3, including housing plastic parts, housing aluminum parts, magnets, and solder.

3.4.4. Semiconductors

Semiconductor components get more efficient per operation with each technology generation, just as the shrinking dimensions require less energy. In this sense 7nm technology can be considered BAT, but this efficiency gain is compensated by increasing computing performance and advanced features – such as embedded artificial intelligence –, which does not necessarily reduce overall energy consumption of integrated circuits. The increasing implementation of thermal management measures in high-end smartphones and tablets, such as heatpipes, is an indicator of this kind of rebound: Although processors are increasingly energy efficient, power losses result in thermal challenges for the devices. In case of flash memory the advancement in technology nodes also results in efficiency gains, but is turned into increasingly higher storage capacity of high-end phones and tablets, which also means a higher environmental footprint of producing the storage components.

3.5. BNAT – Best Not Available Technology

BNAT indicates long-term possibilities and helps to define the exact scope and definition of possible measures (Kemna et al. 2005). This analysis is partly speculative as the impact and actually also the later market introduction of not yet available technology is highly uncertain.

3.5.1. Housing with 100% recycled plastics

On the example of a DECT phone the feasibility of using 100% recycled Acrylonitrile Butadiene Styrene (rABS) in the caseworks has been demonstrated (Ford and Fisher 2019): “Materials testing on the rABS demonstrated that 100% recycled ABS has similar properties to virgin ABS and can be substituted for virgin ABS as long as the product design allows for the slightly stiffer nature of the rABS and addresses issues of surface finish and ability to colour.” Colouring was achieved by adding a 3% master batch – which actually means, recycled content in the end is slightly below 100%. The surface finish was not as good in these trials as for virgin material and a matte surface instead of a gloss finish is strongly recommended. Redesign of clips was implemented in a prototype to account for slightly different material properties of the recycled ABS and to avoid introduction of additional composite parts.

3.5.2. Universal compatibility

Company SHIFT announced the development of a product ecosystem, where a smartphone can act as the computing unit of a tablet once being attached to a display, and the display-smartphone-combo jointly with a (detachable) keyboard and a hub device can work as a kind of laptop computer⁴⁶. Such kind of All-in-one device reduces

⁴⁵ <https://www.apple.com/iphone-12/>

⁴⁶ <https://www.shiftphones.com/en/shiftmu/>

potentially of up to three devices in parallel, thus saves the environmental impacts of redundant parts. This concept has been presented in 2018 and market introduction is announced for 2021. A main challenge apparently is the operating system: For the smartphone Android is intended to be the OS, but Windows shall be fully supported as well for the laptop functionality.

3.5.3. Product modularity

Besides the modular smartphones referenced in the BAT chapter 3.3.1.8 there are several more, which have been developed to a certain prototype level, but have not been introduced to the market (yet), such as the Google ARA project (see the related patent in 3.5.7) and PuzzlePhone (Hankammer et al. 2018; Schischke et al. 2019). These two modularity approaches, which would open up the module development to third parties would come with environmental pros and cons. The drawbacks being the additional hardware for module interfaces and in case of the Google ARA a major risk of a rebound effect when smartphone features can be upgraded too easily. Likely positive effects can be expected through upgrades, if this is embraced by consumers in a moderate way and module upgrade is the alternative to a device new-buy. Easy replacement of defect modules, a removable battery and the possibility to configure a smartphone exactly for own needs – no over dimensioning of features – are further arguments, which lead to the notion, that these concepts can be considered BNAT, if implemented with the aforementioned drawbacks in mind.

3.5.4. Modular RAM and modular SSD

Modular RAM is an option for personal computers and occasionally also for convertible tablets, but there is no known product in scope of the definition of this study with modular RAM. This is apparently due to the fact, that the main computing parts of convertible tablets are in the keyboard part, where the typical thickness allows for modular RAM and related slots on the mainboard, whereas in detachable tablets and all other "slate design" tablets a modular RAM would lead to a less slim design.

A modular M.2 SSD board (flash memory) is however found in the iameco D4R tablet, which is in the prototype stage (Maher et al. 2018).

In smartphones and tablets RAM and flash memory are soldered on the mainboard.

3.5.5. Display cover glass

A new type of glass that can heal itself from cracks and breaks has been developed by a group of Japanese researchers (Yanagisawa et al. 2018). This is made from a low weight polymer called "polyether-thioureas" and can heal breaks when pressed together by hand without the need for high heat to melt the material.

3.5.6. Solid state batteries (SSB)

Solid state batteries replace the highly-flammable electrolyte fluid (or gel) with a ceramics-based solid. While this considerably increases the safety aspects of the batteries, the primary driver behind the commercialization of SSB is to enable the use of lithium metal as the anode, as opposed to the currently used carbon anode, which would result in an estimated 20 % energy density improvement (Ulvestad 2018). Four potential advantages to SSBs have been reported: (1) improved safety (2) higher energy density (3) faster-charging times (i.e. higher power density) and (4) longer life (Gifford and Brown 2020). The development of solid-state batteries that can be manufactured at a large scale is one of the most important challenges in the battery industry today. A stakeholder challenges the statement of improved safety by pointing out, that the flammable organic electrolytes would be replaced by the likewise flammable lithium

metal. In case of fire, burning lithium metal cannot be extinguished with water and requires special means to be extinguished. The overall safety would be rather lower.

3.5.7. Technology Outlook

The product group mobile phones, smartphones, and tablets is characterised by short innovation cycles with respect to most market segments. These innovations might lead to significant changes of product characteristics and need to be reflected in this analysis. In particular use, power consumption, and material efficiency could be influenced towards the better or the worse. Both trends have to be taken into account as they might indicate “Best Not-Yet Available Technology (BNAT)” or might move products in scope of the study in a direction, which is not properly addressed by this study, e.g., with respect to test conditions.

Table 30 provides an overview of some recent patents, which have the potential to influence hardware design of mobile devices significantly. There are many more patents, so this is a non-exhaustive list.

Table 30 : Selection of recent Patents on Mobile Devices with particular Relevancy for Ecodesign

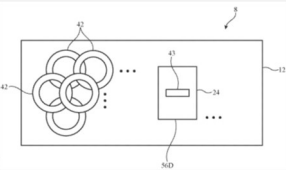
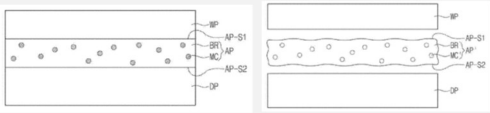
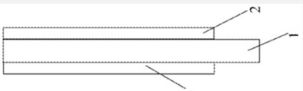
Technology	Patents	Relevancy
wireless multi-device charging pad	<p>US20200059113A1 - Wireless Power System with Device Priority, by Apple Inc., filed on May 23, 2019</p>  <p>US20190074730A1 - Wireless Charging System With Machine-Learning-Based Foreign Object Detection, by Apple Inc., filed on January 19, 2018</p>	Power transmission efficiency might be an issue; device not clearly related to a specific device, but an accessory
ceramics for housings	<p>US010624217 - Yttria-sensitized Zirconia, by Apple Inc., filed on August 8, 2019</p>	Potential material efficiency implications (durability, material composition), and environmental footprint
releasable and removable adhesives	<p>US010316219 - Thermally Releasable Adhesive Member and Display Apparatus including the same, by Samsung Display, filed July 12, 2017</p>  <p>US010435594 B2 - Removable Pressure-Sensitive Adhesive Strip, by Tesa, published October 8, 2019</p> 	Potential material efficiency implications (reparability)

Technology	Patents	Relevancy
------------	---------	-----------

foldable displays

US20200166974 – Electronic Devices with Flexible Displays and Hinges, by Apple Inc., filed on January 30, 2020

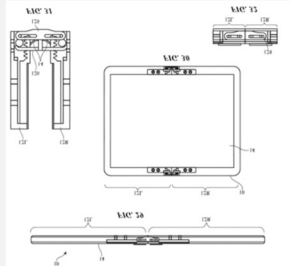

Potential material efficiency implications (lifetime, durability, reparability, material composition), screen size definition

US10564681 - Hinged Device, by Microsoft, filed on February 19, 2019

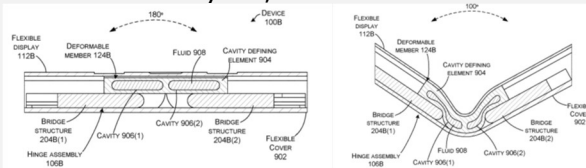

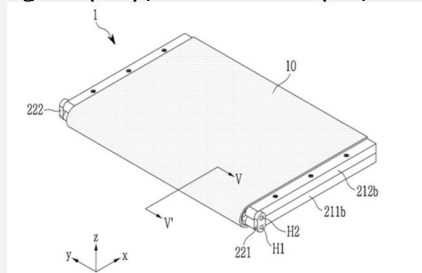

US1010686028 – Foldable Display Device, by Samsung Display, filed January 9, 2019

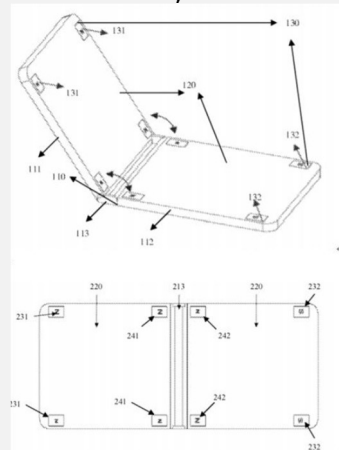

US10671126 – Foldable terminal, by Xiaomi Inc., published June 2, 2020

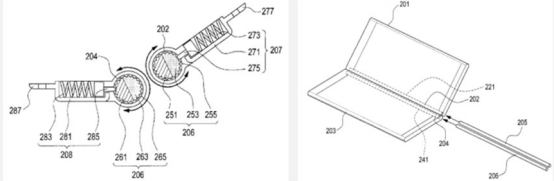
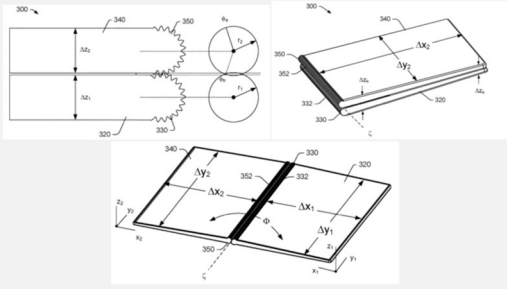
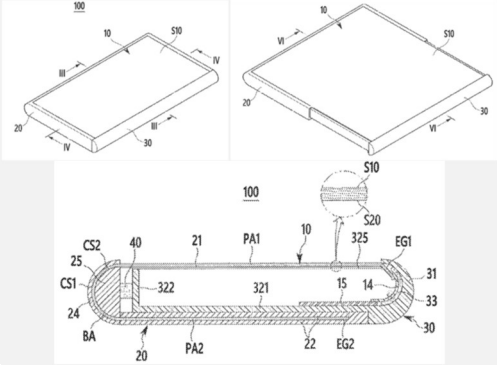
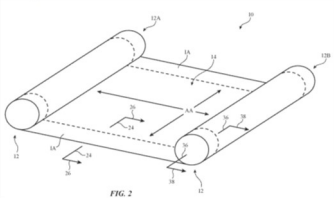
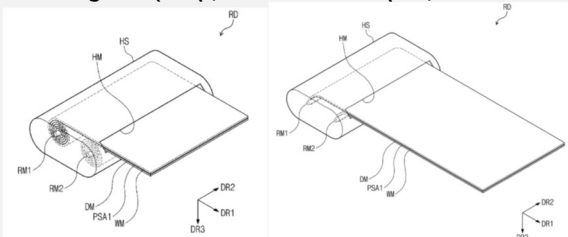

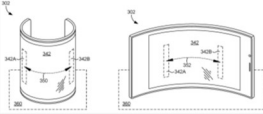
Technology	Patents	Relevancy
display devices with a magnetic hinge	<p data-bbox="467 210 1062 304">US010459493 – Electronic Device Including Plurality of Housings, by Samsung Electronics, filed June 11, 2018</p>  <p data-bbox="467 488 1075 582">US010345866 – Computing Device with A Magnetic Hinge, by Lenovo, filed February 7, 2017</p> 	Potential material efficiency implications (lifetime, durability, reparability, material composition), definition of the “product”
expandable display	<p data-bbox="467 904 1067 965">US010553135 – Expandable Display Device, by Samsung Display, filed October 4, 2017</p> 	Potential material efficiency implications (lifetime, durability, reparability, material composition), screen size definition
rollable displays	<p data-bbox="467 1335 1035 1429">US20200196460 - Electronic Display with Flexible Display Structures, by Apple Inc., filed February 21, 2020</p>  <p data-bbox="467 1630 1062 1691">US010671124 – Rollable Display Device, by Samsung Display, filed January 2, 2019</p> 	Potential material efficiency implications (lifetime, durability, reparability, material composition), screen size definition

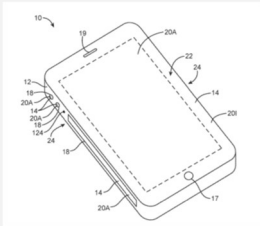
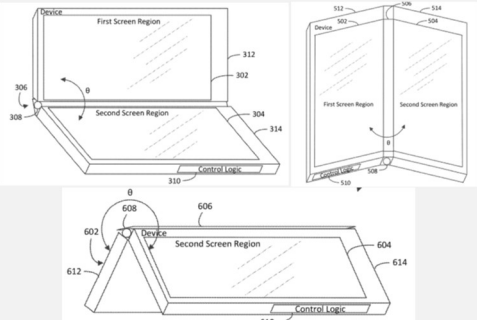
Technology	Patents	Relevancy
bendable displays	<p data-bbox="467 208 1082 302">US010545900 B2 – Physical Configuration of a Device for Interaction Mode Selection, by Microsoft, published on January 28, 2020</p> 	<p data-bbox="1114 208 1386 432">Potential material efficiency implications (lifetime, durability, reparability, material composition)</p>
flexible device	<p data-bbox="467 436 1082 499">US0D0880475 – Flexible Electronic Device, by Lenovo, filed May 6, 2019</p> 	<p data-bbox="1114 436 1386 660">Potential material efficiency implications (lifetime, durability, reparability, material composition)</p>
flexible batteries	<p data-bbox="467 761 1082 855">US010312479 B2 – Flexible Rechargeable Battery, by Samsung SDI, published June 4, 2019</p>	<p data-bbox="1114 761 1386 920">Potential material efficiency implications (lifetime, durability, reparability)</p>
sidewall displays	<p data-bbox="467 925 1082 1019">US010521034 – Electronic Displays with Sidewall Displays, by Apple Inc., filed May 24, 2019</p>  <p data-bbox="467 1247 1082 1373">US010346117 B2 – Device Having a Screen Region on a Hinge Coupled Between Other Screen Regions, by Microsoft, published July 9, 2019</p> 	<p data-bbox="1114 925 1386 1149">Potential material efficiency implications (lifetime, durability, reparability, material composition)</p>

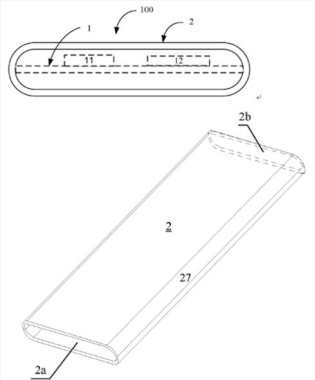
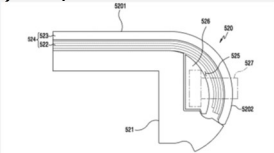
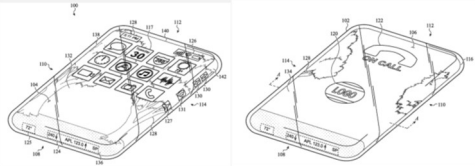
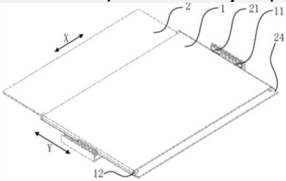
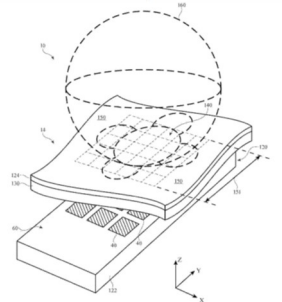
Technology	Patents	Relevancy
display wrapping around device	<p>US9838518 Mobile device with display wrapping around surfaces, by Xiaomi Inc., published Dec 5, 2017</p> 	Potential material efficiency implications (lifetime, durability, reparability, material composition)
side bent glass with touch controls	<p>US010561027 – Electronic Device Including Bent Display and Method of Displaying Image on Bent Display, by Samsung Electronics, filed February 28, 2018</p> 	Potential material efficiency implications (lifetime, durability, reparability, material composition)
glass enclosure	<p>US 20200057525 – Electronic Device with Glass Enclosure, by Apple Inc., filed August 15, 2019</p> 	Potential material efficiency implications (lifetime, durability, reparability, material composition)
magnetic slide rail to hide camera	<p>US010686919 B2 – Slide Rail and Mobile Terminal, by Xiaomi, filed July 3, 2019</p> 	
hardening of glass	<p>US20200181007 – Spiral Grain Coatings for Glass Structures in Electronic Devices, by Apple Inc., filed June 28, 2019</p>	Durability of cover and backside glasses
antennas radiating through display	<p>US20200136234 – Electronic Devices Having Antennas that Radiate Through a Display, by Apple Inc., filed January 30, 2018</p> 	Device does not need a radio permeable (potentially glass) back cover for 5G

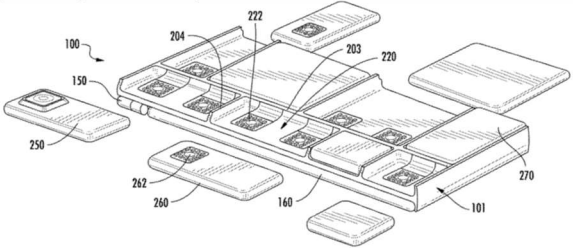
Technology	Patents	Relevancy
modularity	US10673996 B2 – Modular Electronic Device, by Google LLC, published June 2, 2020 	Potential material efficiency implications (lifetime, durability, reparability, material composition), definition of the "product"

Although by far not all patents will make it into real products, the patent analysis indicates a strong trend towards innovative display designs, which might or might not be flexible, foldable and cover increasingly more surfaces of the device. Extrapolating from past reliability experiences with any kind of movable mechanism (hinges, mechanical keys, connectors) in ICT equipment indicates, that this likely leads to new reliability issues. Similarly, given that drops are a major reason of device defects nowadays, extending the display area to additional surfaces increases the likeliness, that mobile phones drop on a display part. The introduction of flexible displays on the other hand might reduce the risk of breakage compared to current rigid display designs. Given that flexible displays will interact with some kind of mechanics, it remains to be seen what will constitute a "spare part", i.e. to which level a display – bending mechanism – combo needs to be disassembled for replacing defect parts.

Also the definition of the display size (see Task 1) needs to reflect future new display designs. The same is the case for reliability testing, such as: definition of bending cycles, operational mode in which e.g. a device is dropped – folded or unfolded, etc.

Regarding the use of materials the patent analysis indicates a trend towards micro-mechanics, which likely leads to a higher share of metal components, and as closing or fixing in these patents frequently depends on magnetic force the use of rare earth elements containing magnets is likely to increase.

4. SUBTASK 4.2 – PRODUCTION, DISTRIBUTION AND END-OF-LIFE

From this analysis onwards the following steps shall be guided by base cases, which are supposed to represent larger market segments, but typically are not a specific real-world product.

Based on the technical analysis above base cases are defined as follows:

- BC1: Smartphone, display 5", low-end price segment
- BC2: Smartphone, display 6", mid-range
- BC3: Smartphone, display 6,5", high-end
- BC4: Feature phone
- BC5: DECT cordless landline phone, with charging cradle / base station
- BC6: Tablet (no attached keyboard)

Assessment of these base cases with the EcoReport tool as required by the MEErP methodology follows in task 5. The following chapters outline the specifics of the base cases as regards the entries in the EcoReport input tables and particular differences between the base cases.

The smartphone base cases 1-3 approximate the three market segments of entry-level or budget phones, the mid-range price segment, and the high-end or flagship or premium segment as specified in Table 2, p. 20. At the same time, these base cases represent 3 different popular display size ranges of 5", 6", and 6,5". These 3 base cases are meant to represent roughly 1/3 of the smartphone market each.

4.1. Product weight and Bills-of-Materials (BOMs)

The Bill of Materials of the 6 base cases is structured as listed in Table 31. Weights reflect the analysis in 3.1.

Table 31 : Bill of Materials structure for base cases and approximate product weights (excluding accessories and packaging)

	BC1	BC2	BC3	BC4	BC5	BC6
Battery	Yes	Yes	Yes	Yes	Yes	Yes
Display	Yes	Yes	Yes	Yes	Yes	Yes
Housing	Yes	Yes	Yes	Yes	Yes	Yes
Mainly plastics	Yes	Yes		Yes	Yes	1/2
Mainly metal			Yes			1/2
Glass backcover			Yes			
Key pad				Yes	Yes	
Camera(s)	Yes	Yes	Yes	Yes		Yes
Audio components	Yes	Yes	Yes	Yes	Yes	Yes
Mainboard, other PCBs	Yes	Yes	Yes	Yes	Yes	Yes
Heatpipes			Yes			
Wireless charging coil			Yes			
Other minor parts	Yes	Yes	Yes	Yes	Yes	Yes
Charger	Yes	Yes	Yes	Yes	Yes	Yes
Other accessories	Yes	Yes	Yes	Yes	Yes	Yes
Base station / charging cradle					Yes	
Product weight (g)	150	180	195	85	105	600

Typical weight of accessories is

- 25 g USB / charging cable
- 20 g headset
- 40 g power supply mobile phone
- 60 g power supply cordless phone
- 80 g power supply tablet
- 160 g base station / charging cradle for cordless phone

4.2. Assessment of the primary scrap production during sheet metal manufacturing

Where sheet metal parts are used as, e.g. shieldings, these are shaped according to the shielding needs of the covered parts or areas on the printed circuit board and not optimised for cut off minimisation. Given the geometries of such metal sheet parts a rather high share of 50% metal sheet scrap is estimated.

For the metal frame and housing parts made of aluminium or rarely steel, the input material is not sheet metal but extruded metal parts, which are then CNC machined to carve out cavities, actually with the aim to reach a lightweight overall design. This

actually means that most of the material is removed from the workpiece. The material yield with such a design and manufacturing approach can be as low as 20% and 80% of the material is actually lost and potentially recycled. As the EcoReport does not include these significant machining losses, extra material input is entered in the BoM input table to reflect these losses.

4.3. Packaging materials

Packaging materials for all products are mainly cardboard boxes, partly with plastics inlays, but more frequently with cardboard segmentation for the accessories. In few cases the package comes with a polycarbonate cover to display the product to the potential buyer, or with a polycarbonate internal package for accessories, such as a separate headset case. Manuals and other product information is limited to a minimum in most cases.

Packaging weights per base case are:

Table 32 : Base Cases – Packaging materials weights

BC		Weight (g)
1	Smartphone, 5", low-end price segment	200
2	Smartphone, 6", mid-range	250
3	Smartphone, 6,5", high-end	300
4	Feature phone	300
5	DECT cordless landline phone, with charging cradle / base station	120
6	Tablet	600

4.4. Volume and weight of the packaged product

Based on a sample of 8 smartphone packages total package volumes are as listed in Table 33, including the share of the package actually occupied by the charger.

Table 33 : Package dimension of exemplary smartphones (analysis by Fraunhofer IZM)

No.	Total Package				Charger packaging size share				
	L (cm)	W (cm)	H (cm)	V (cm ³)	L (cm)	W (cm)	H (cm)	V (cm ³)	share of total package
1	13	7	5	455	5	6,5	2,3	75	16%
2	14,6	8	5,2	607	5	7	2,3	81	13%
3	13,1	7,9	4,8	497	7	6,8	2,3	109	22%
4	15	8,3	5,4	672	4	7,5	2,4	72	11%
5	15,5	8,3	5,1	656	7,7	3,5	2,4	65	10%
6	15,5	8,5	5,1	672	8,3	7	2,3	134	20%
7	15,5	8,5	4,7	619	3,5	7	1,3	32	5%
8	15,6	8,5	4,9	650	3,5	3,5	0,8	10	2%
9	16,8	16,8	3,8	1073	8,8	7,2	2,8	177	17%
Average									13%

Packaging sizes for mobile phones are typically defined by the length and width of the devices plus some cardboard wall thickness, and height is defined by the space requirements of accessories typically placed underneath the handset.

Typical package sizes are stated in Table 34.

Table 34 : Base Cases - Package dimensions

BC		Total Package				Weight (g)
		L (cm)	W (cm)	H (cm)	V (cm ³)	
1	Smartphone, 5", low-end price segment	15,5	8,5	5	660	435
2	Smartphone, 6", mid-range	16,0	8,5	5	680	515
3	Smartphone, 6,5", high-end	17,5	8,5	5	745	580
4	Feature phone	13,5	7,5	5	505	470
5	DECT cordless landline phone, with charging cradle / base station	22,0	16,0	6,5	2290	445
6	Tablet	27,5	18,5	4	2035	1325

4.5. Actual means of transport employed in shipment of components, sub-assemblies and finished products

Most of the products are assembled and packaged in East Asian countries, and also major parts and components, such as batteries and display units are produced in South Korea, Japan, Taiwan and China. It is not known, how exactly the numerous components are shipped, but it can be assumed, that due to time critical manufacturing processes, small sizes and high values short distance air freight is also common besides ground transportation.

Finished products in the vast majority of the cases are shipped in their sales packages from East Asia to the EU. As there is still a relevant production base for cordless phones within the EU-27 transport of packaged products by trucks and trains is apparently a relevant means of transportation for these. Given the short innovation cycles intercontinental air freight is the typical means of transportation for smartphones and tablets. Feature phones and cordless phones might also be shipped with container vessels.

4.6. Technical product life

The most critical part in terms of technical product life is the battery, which can last above 1000 charging cycles, but is subject to time-dependent and charge-cycle dependent ageing. Other parts of a phone or tablet are much more subject to failures due to drops on the ground or in water or similar. In this sense the parts identified in task 3 are candidates to fail due to such events.

Table 35 : Base Cases – Active use lifetime

BC		Active product lifetime
1	Smartphone, 5", low-end price segment	2,5 years (30 months)
2	Smartphone, 6", mid-range	3 years (36 months)
3	Smartphone, 6,5", high-end	3,5 years (42 months)
4	Feature phone	3 years (36 months)
5	DECT cordless landline phone, with charging cradle / base station	5 years (60 months)
6	Tablet	5 years (60 months)

The modelling of the base cases with the EcoReport is based on the active use lifetime as defined in task 2. To reflect the finding, that higher priced devices apparently have a longer product use time as performance limitations will show up later (see technical analysis in this task report), OS support is provided in some cases longer (see 3.2.8.1), as the high price is a barrier for early replacement (see task 3 report) and as there is a larger reuse and recommerce market for these devices (see task 2 report), a staged active use lifetime is considered for the 3 smartphone base cases. For the other product segments active use lifetimes are as identified in task 2.

4.7. Materials flow and collection effort at end-of-life

Data on end-of-life of the products in scope of the study are presented in 3.1, including insights regarding reuse outside the EU27, recycling, disposal as household waste and hibernation, the latter leading sooner or later into one of the other EoL paths. The modelled end-of-life scenario applied to the base cases is presented and detailed in Task 5.

5. PUBLICATION BIBLIOGRAPHY

Apple (2020a): Environment. Available online at <https://www.apple.com/environment/>, updated on 10/6/2020, checked on 10/6/2020.

Apple (2020b): Apple Events - October 2020. Available online at <https://www.apple.com/apple-events/october-2020/>, updated on 10/20/2020, checked on 10/20/2020.

Apple Inc. (2020): Environmental Progress Report. Covering fiscal year 2019. Available online at https://www.apple.com/environment/pdf/Apple_Environmental_Progress_Report_2020.pdf.

Arduin, R. H.; Charbuillet, C.; Berthoud, F.; Perry, N. (2017): Life Cycle Assessment of End-of-Life Scenarios: Tablet Case Study. In *Proceedings Sardinia 2017 / Sixteenth International Waste Management and Landfill Symposium*.

B3 Corp.: E16Q3 LIB Market Bulletin chapter 4.

B3 Corp.: E19Q1 LIB materials markets.

B3 Corp.: E19Q3 LIB market chapter 4.

Barrett, Brian (2020): Your Next Smartphone Will Be a Lot Harder to Scratch. Available online at <https://www.wired.com/story/gorilla-glass-victus/>, updated on 10/7/2020, checked on 10/7/2020.

Barsukov, Yevgen; Qian, Jinrong (2013): Battery power management for portable devices. Boston: Artech House (Artech House power engineering series).

BBC (2017): Samsung confirms battery faults as cause of Note 7 fires. In *BBC News*, 1/23/2017. Available online at <https://www.bbc.com/news/business-38714461>, checked on 12/2/2021.

Berwald, Anton; Clemm, Christian; Prewitz, Carolin (2020): Environmental evaluation of current and future design rules. Deliverable no. 2.5 of the EU H2020 PROMPT project. Available online at <https://prompt-project.eu/>.

Bohn, Dieter (2020): Samsung guarantees three 'generations' of Android OS updates for some Galaxy phones. There are some caveats for A-series phones. Edited by The Verge. Available online at <https://www.theverge.com/2020/8/5/21355777/samsung-android-os-update-promise-galaxy-phones-3-generations>, updated on 8/5/2020, checked on 9/29/2020.

Bookhagen, Britta; Dorner, Ulrike; Damm, Sophie; Bergholtz, Jana; Opper, Christine; Irrgeher, Johanna et al. (2018): Rohstoffverbrauch von Smartphones. In *Recycling und Rohstoffe* Band 11, pp. 519–532. Available online at https://www.vivis.de/wp-content/uploads/RuR11/2018_RuR_519-532_Bookhagen.

Clemm, Christian; Berwald, Anton; Prewitz, Carolin (2020): Evolution of Smartphone Design and Implications for Material Efficiency. In *Electronics Goes Green 2020+*.

Clemm, Christian; Mähltitz, Paul; Schlösser, Alexander; Rotter, Vera Susanne; Lang, Klaus-Dieter (2016a): Umweltwirkungen von wiederaufladbaren Lithium-Batterien für den Einsatz in mobilen Endgeräten der Informations- und Kommunikationstechnik (IKT). Edited by Umweltbundesamt. Dessau, Germany (Texte, 52/2016). Available online at <https://www.umweltbundesamt.de/publikationen/umweltwirkungen-von-wiederaufladbaren-lithium>.

Clemm, Christian; Sinai, C.; Ferkinghoff, C.; Dethlefs, N.; Nissen, N. F.; Lang, K.-D. (2016b): Durability and cycle frequency of smartphone and tablet lithium-ion batteries in the field. In : 2016 Electronics Goes Green 2016+ (EGG). 2016 Electronics Goes Green 2016+ (EGG), pp. 1–7.

Cordella, Mauro; Alfieri, Felice; Sanfelix, Javier (2020): Guidance for the Assessment of Material Efficiency: Application to Smartphones. Edited by Publications Office of the European Union. Luxembourg (JRC116106).

Corning (2020a): CORNING® GORILLA® GLASS 5. Available online at https://www.corning.com/microsites/csm/gorillaglass/PI_Sheets/2020/Corning%20Gorilla%20Glass%205_PI%20Sheet.pdf, checked on 7/10/2020.

Corning (2020b): CORNING® GORILLA® GLASS 6. Available online at <https://www.corning.com/gorillaglass/worldwide/en/glass-types/gorilla-glass-6.html>.

Corning (2020c): Corning® Gorilla® Glass Victus™. Available online at https://www.corning.com/microsites/csm/gorillaglass/PI_Sheets/2020/Corning%20Gorilla%20Glass%20Victus_PI%20Sheet.pdf, checked on 7/10/2020.

Derks, Maarten (2020): Building a breakthrough for Fairphone 2. Edited by Fairphone. Available online at

<https://www.fairphone.com/en/2020/06/18/fairphone-2-gets-android-9/>, updated on 6/30/2020, checked on 9/29/2020.

Dixon, Taylor (2020): The Pixel 4a Is Actually New and Interesting, Once You Open It - iFixit. Available online at <https://de.ifixit.com/News/43537/the-pixel-4a-is-actually-new-and-interesting-once-you-open-it>, updated on 9/22/2020, checked on 9/22/2020.

Du, Li (2016): Du, L. "An Overview of Mobile Capacitive Touch An Overview of Mobile Capacitive Touch Technologies Trends. In *ArXiv abs/1612.08227*.

Electronicproducts (2016): What's inside? Product teardowns. Available online at <http://www.electronicproducts.com>, checked on 1/15/2017.

Ellen MacArthur Foundation (2012): In-depth - Mobile Phones. Available online at <https://www.ellenmacarthurfoundation.org/news/in-depth-mobile-phones>, updated on 9/16/2020, checked on 9/16/2020.

European Bioplastics: What are bioplastics? Available online at <https://www.european-bioplastics.org/bioplastics/>.

European Commission (2019): Impact assessment study on common chargers of portable devices. Available online at <https://op.europa.eu/en/web/eu-law-and-publications/publication-detail/-/publication/c6fadfea-4641-11ea-b81b-01aa75ed71a1>.

Fairphone (2018): Digging into the recycled material chains - Fairphone. Available online at <https://www.fairphone.com/de/2018/04/26/digging-into-the-recycled-material-chains/>, updated on 7/25/2018, checked on 9/16/2020.

Fairphone (2020): A new milestone in fairer electronics: Introducing Fairphone 3+ - Fairphone. Available online at <https://www.fairphone.com/de/2020/08/27/introducing-fairphone-3-plus/>, updated on 8/27/2020, checked on 9/10/2020.

Feurer, Sebastian (2020): iOS 14: Diese iPhones bekommen das Update. Edited by chip. Available online at https://www.chip.de/news/iOS-14-Diese-iPhones-bekommen-das-Update_182551984.html, updated on 9/29/2020, checked on 9/29/2020.

Ford, Peter; Fisher, Jill (2019): Designing consumer electronic products for the circular economy using recycled Acrylonitrile Butadiene Styrene (ABS): A case study. In *Journal of Cleaner Production* 236, p. 117490. DOI: 10.1016/j.jclepro.2019.06.321.

Gifford, Stephen; Brown, Zachary (2020): Solid-State Batteries: The Technology of the 2030s but the Research Challenge of the 2020s. Available online at https://faraday.ac.uk/wp-content/uploads/2020/04/Faraday-Insights-5_Updated.pdf, checked on 5/10/2020.

Google (2020a): Pixel 4a. Product environmental report. Available online at <https://www.gstatic.com/gumdrop/sustainability/pixel4a-product-environment-report.pdf>.

Google (2020b): Reports | Google Sustainability. Available online at <https://sustainability.google/reports/>, updated on 10/6/2020, checked on 10/6/2020.

GSMarena (2020): Battery life tests results. Available online at <https://www.gsmarena.com/battery-test.php3>, updated on 10/6/2020, checked on 10/6/2020.

Hankammer, Stephan; Jiang, Ruth; Kleer, Robin; Schymanietz, Martin (2018): Are modular and customizable smartphones the future, or doomed to fail? A case study on the introduction of sustainable consumer electronics. In *CIRP Journal of Manufacturing Science and Technology* 23, pp. 146–155. DOI: 10.1016/j.cirpj.2017.11.001.

iFixit (2019): Samsung Galaxy Fold tear down. Available online at <https://fr.ifixit.com/Tutorial/Vue+%C3%A9clat%C3%A9+du+Samsung+Galaxy+Fold/122600>.

iFixit (2020): Motorola Razr tear down. Available online at <https://fr.ifixit.com/Tutorial/Vue+%C3%A9clat%C3%A9+du+Motorola+Razr/130414>.

Ipsos, Trinomics, Fraunhofer FOKUS, Economisti Associati (2019): Impact Assessment Study on Common Chargers of Portable Devices. Edited by Publications Office of the European Union. European Commission. Luxembourg.

Jardim, Elizabeth (2017): From Smart to Senseless. The Global Impact of 10 Years of Smartphones. Available online at <http://www.greenpeace.org/usa/wp-content/uploads/2017/03/FINAL-10YearsSmartphones-Report-Design-230217-Digital.pdf>, checked on 9/16/2020.

Kalluri, Sujith; Yoon, Moon-su; Jo, Minki; Park, Suhyeon; Myeong, Seungjun; Kim, Junhyeok et al. (2017): Surface Engineering Strategies of Layered LiCoO₂ Cathode Material to Realize High-Energy and High-Voltage Li-Ion Cells. *Advanced Energy Materials*, 7(1), 1601507. In *Adv. Energy Mater.* 7 (1), p. 1601507. DOI: 10.1002/AENM.201601507.

Kemna, René (2011): Methodology for Ecodesign of Energy-related Products - MEErP 2011. Methodology Report. Part 1: Methods. With assistance of Nelly Azais, Martijn van Elburg, Maaike van der Voort, William Li. Brussels / Delft.

Kemna, René; van Elburg, Martijn; Li, William; van Holsteijn (2005): Methodology Study Eco-design of Energy-using Products. Final Report, MEEUP Methodology Report. Edited by European Commission. Delft, The Netherlands, Brussels, Belgium.

Kemna, René; Wierda, Leo; Li, William; van den Boorn, Roy; van Elburg, Martijn; Viegand, Jan; Wu, Anson (2020): ICT Impact study. Technical Assistance, Final Report.

Li, Hongxia; Ning, Nanying; Zhang, Liqun; Wang, Yanxiang; Liang, Wenli; Tian, Ming (2014): Different flame retardancy effects and mechanisms of aluminium phosphinate in PPO, TPU and PP. In *Polymer Degradation and Stability* 105, pp. 86–95. DOI: 10.1016/j.polymdegradstab.2014.03.032.

MacRumors Forums (2021): iPhone 12 Camera Repairs Require Apple's Proprietary System Configuration Tool. Available online at <https://forums.macrumors.com/threads/iphone-12-camera-repairs-require-apples-proprietary-system-configuration-tool.2264651/>, updated on 2/12/2021, checked on 2/12/2021.

Maher, Paul; Ospina, Jose; Galligan, Anne; Schischke, Karsten; Gallagher, John; Madden, Jeremy; O'Donovan, Dermot (2018): D4R tablet: Concept and technology validation. Deliverable 1.3. Project Sustainable Smart Mobile Devices Lifecycles through Advanced Re-design, Reliability, and Re-use and Remanufacturing Technologies. Available online at <https://www.sustainably-smart.eu/app/download/9094792682/D4R-tablet-kappa.pdf?t=1574689220>.

Manhart, Andreas; Blepp, Markus; Fischer, Corinna; Graulich, Kathrin (2016): Resource Efficiency in the ICT Sector. Available online at https://www.greenpeace.de/sites/www.greenpeace.de/files/publications/20161109_oeko_resource_efficiency_final_full-report.pdf, checked on 7/9/2020.

Maya-Drysdale, Larisa; Peled, Michelle; Wood, Jonathan; Rames, Mette; Viegand, Jan (2017a): Preparatory study on the Review of Regulation 617/2013 (Lot 3) Computers and Computer Servers. Simplified tasks 5 & 6 report Base cases and Design options. Brussels, Belgium. Available online at <https://www.semanticscholar.org/paper/An-Overview-of-Mobile-Capacitive-Touch-Technologies-Du/98b52004fe8a3cb4b961c6fa52068699b3fa7264>.

Maya-Drysdale, Larisa; Peled, Michelle; Wood, Jonathan; Rames, Mette; Viegand, Jan (2017b): Preparatory study on the Review of Regulation 617/2013 (Lot 3) Computers and Computer Servers. Task 4 report - Technologies. Brussels, Belgium. Available online at <https://www.semanticscholar.org/paper/An-Overview-of-Mobile-Capacitive-Touch-Technologies-Du/98b52004fe8a3cb4b961c6fa52068699b3fa7264>.

Mobile & SecurityLab (2019): Smartphones with the best security updates, comparison with other main smartphones. twitter. Available online at <https://twitter.com/SecX13>, checked on 9/28/2020.

Mudgal, Shailendra; Tinetti, Benoît; Prado Trigo, Alvaro de; Faninger, Thibault; Schischke, Karsten; Proske, Marina et al. (2013): Material-efficiency ecodesign report and module to the methodology for the ecodesign of energy-related products (MEErP). Part 1, material efficiency for ecodesign - Study. Brussels.

Nelson (2020): 2020 Moto RAZR Durability Test! - Will the Folding Icon Survive!? Available online at <https://www.youtube.com/watch?v=Eokt7DWljtU>.

Nissen, Nils F.; Reinhold, Julia; Schischke, Karsten; Lang, Klaus-Dieter (2019): Recyclability of Tungsten, Tantalum and Neodymium from Smartphones. In *EcoDesign 2019 Proc.*

Notebookcheck (2020): Benchmarks and Test Results. Available online at https://www.notebookcheck.net/Benchmarks-and-Test-Results.142793.0.html?&type=model&model_class=10&max_results=500&archive=1&or=0&showBars=1&test_current_current_off=1&test_current_current_standby=1&test_current_current_idle_avg=1&test_current_current_load_avg=1&model=1&cpu_name=1&screen_size=1, updated on 10/6/2020, checked on 10/6/2020.

O'Rangers, J. (2020): Samsung Parts Serialization: What Is It? cdc cellular repair services. Available online at <https://www.cdccellularrepair.com/post/samsung-parts-serialization-what-is-it>, updated on 10/22/2020, checked on 2/12/2021.

Ospina, Jose; Maher, Paul; Galligan, Anne; Gallagher, John; O'Donovan, Dermot; Knorr, Stefan; Schischke, Karsten (2019): Design and Manufacture of the iameco D4R Tablet in a Fab Lab Environment. In *Proc. Proudct Lifecycles and the Environment - PLATE 2019*.

Phone Arena (2021): Samsung Galaxy S21 release date, price, features and news. Available online at <https://www.phonearena.com/samsung-galaxy-s30-s21-plus-ultra-release-date-price-features-news>, updated on 2/12/2021, checked on 2/12/2021.

Pillot, Christophe (2017): The Rechargeable Battery Market and Main Trends 2016-2025. In *The Battery Show, North America 2017*. Available online at http://www.avicenne.com/pdf/The%20Rechargeable%20Battery%20Market%20and%20Main%20Trends%202016-2025_C%20Pillot_M%20Sanders_September%202017.pdf, checked on 5/10/2020.

Pramanik, Pijush Kanti Dutta; Sinhababu, Nilanjan; Mukherjee, Bulbul; Padmanaban, Sanjeevikumar; Maity, Aranyak; Upadhyaya, Bijoy Kumar et al. (2019): Power Consumption Analysis, Measurement, Management, and Issues: A State-of-the-Art Review of Smartphone Battery and Energy Usage. *IEEE Access*, 7, 182113-182172. In *IEEE Access* 7, pp. 182113-182172. DOI: 10.1109/ACCESS.2019.2958684.

Proske, Marina; Baur, Sarah-Jane; Rückschloss, Jana; Teusch, Christoph; Krause, Thomas; Poppe, Erik (2020a): Bestandsaufnahme Smartphones. Übersicht Modellhistorie und modulare Konzepte. Projektbericht MoDeSt.

Proske, Marina; Clemm, Christian; Richter, Nikolai (2016): Life Cycle Assessment of the Fairphone 2. Final Report. Berlin. Available online at https://www.fairphone.com/wp-content/uploads/2016/11/Fairphone_2_LCA_Final_20161122.pdf.

Proske, Marina; Sánchez, David; Clemm, Christian; Baur, Sarah-Jane (2020b): Life Cycle Assessment of the Fairphone 3. Fraunhofer IZM. Amsterdam, The Netherlands. Available online at https://www.fairphone.com/wp-content/uploads/2020/07/Fairphone_3_LCA.pdf, checked on 9/27/2020.

Requirements for Computers.

SamMobile (2020): Galaxy S20 Ultra has Gorilla Glass 6 on the front and back. Available online at <https://www.sammobile.com/news/galaxy-s20-ultra-has-gorilla-glass-6-on-the-front-and-back/>, updated on 10/7/2020, checked on 10/7/2020.

Samsung (2020): Umweltbewusste Produkte | Umwelt | Nachhaltigkeit | Samsung DE. Available online at <https://www.samsung.com/de/aboutsamsung/sustainability/environment/eco-conscious-products/>, updated on 9/10/2020, checked on 9/10/2020.

Sánchez et al. (2018): Technology assessment of wireless charging using life cycle tools. Presentation at the CARE conference. Available online at <http://ci2018.care-electronics.net/>.

Sander, Knut; Marscheider-Weidemann, Frank; Wilts, Henning; Hobohm, Julia; Hartfeil, Thorsten; Schöps, Dirk; Heymann, René (2019): Abfallwirtschaftliche Produktverantwortung unter Ressourcenschutzaspekten (RePro). Dessau, Germany (Texte | 52/2019).

Schischke, Karsten; Nissen, Nils F.; Stobbe, Lutz; Oerter, Markus; Scheiber, Sascha; Schlösser, Alexander et al. (2014): Ansätze zur stofflichen Verwertung von Tablets aus Sicht des Produktdesigns. In *Recycling und Rohstoffe* Band 7. Available online at <http://www.vivis.de/fachbuecher/recycling-und-rohstoffe/184-rur7>.

Schischke, Karsten; Proske, Marina; Nissen, Nils F.; Schneider-Ramelow, Martin (2019): Impact of modularity as a circular design strategy on materials use for smart mobile devices. In *MRS Energy & Sustainability* 6 (E16). DOI: 10.1557/mre.2019.17.

Sosnowsky, Rudolf (2020): Peripherie: 1, 2, 3, 4 – USB kann wieder mehr. Available online at <https://www.elektroniknet.de/design-elektronik/embedded/1-2-3-4-usb-kann-wieder-mehr-178135.html>, updated on 10/5/2020, checked on 10/5/2020.

Tecchio, Paolo; Ardente, Fulvio; Marwede, Max; Clemm, Christian; Dimitrova, Gergana; Mathieux, Fabrice (2018): Analysis of material efficiency aspects of personal computers product group. Luxembourg: Publications Office (EUR. Scientific and technical research series, 28394).

Thielmann, A. et al. (2017): 2017 Energiespeicher-Roadmap (update 2017) – Hochenergie Batterien 2030+ und Perspektiven zukünftiger Batterietechnologien. Edited by Fraunhofer Institute for Systems and Innovation Research ISI. Karlsruhe, Germany.

UFC QC (2020): Test des Samsung Galaxy S20+ et S20 Ultra Des smartphones trop fragiles ! Available online at

<https://www.quechoisir.org/actualite-test-des-samsung-galaxy-s20-et-s20-ultra-des-smartphones-trop-fragiles-n78307/>.

Ulvestad, Andrew (2018): A Brief Review of Current Lithium Ion Battery Technology and Potential Solid State Battery Technologies. Available online at <https://arxiv.org/ftp/arxiv/papers/1803/1803.04317.pdf>, checked on 5/10/2020.

Umicore (2020): Closing the loop for cobalt in consumer devices' batteries (2018) | Annual report 2019. Available online at <https://annualreport.umicore.com/stories/closing-the-loop-for-cobalt-in-consumer-devices-batteries/>, updated on 9/16/2020, checked on 9/16/2020.

van der Voort, Darell (2013): From Mobile Phone to Urban Mine. An analysis of the potentials and process of mobile phone recycling in Belgium. Available online at <https://edepot.wur.nl/305511>.

Vincent, James (2020): Apple's new iPhone 12 line-up comes with a ceramic-hardened display. In *The Verge*, 10/13/2020. Available online at <https://www.theverge.com/2020/10/13/21509008/apple-iphone-12-pro-max-mini-displays-ceramic-hardened>, checked on 10/20/2020.

Warner, John T. (2019): Lithium-ion battery chemistries. A primer / John T. Warner. Amsterdam: Elsevier.

Watson, David; Tojo, Naoko; Bauer, Bjørn; Milios, Leonidas; Gylling, Anja Charlotte; Throne-Holst, Harald (2017): Circular Business Models in the Mobile Phone Industry: Nordic Council of Ministers.

Webb, Olivia (2020): Here Are the Parts You Can Swap Between the New iPhone SE and iPhone 8 - iFixit. Available online at <https://de.ifixit.com/News/41123/here-are-the-parts-you-can-swap-between-the-new-iphone-se-and-iphone-8>, updated on 9/22/2020, checked on 9/22/2020.

Wölbart, Christian (2016): Sammeln, schreddern, schmelzen. Wie Elektronik recycelt wird. Edited by Heise Magazine. Available online at <https://www.heise.de/select/ct/2016/5/1456989946257904>, updated on 9/30/2020, checked on 9/30/2020.

Yanagisawa, Yu; Nan, Yiling; Okuro, Kou; Aida, Takuzo (2018): Mechanically robust, readily repairable polymers via tailored noncovalent cross-linking. In *Science (New York, N.Y.)* 359 (6371), pp. 72–76. DOI: 10.1126/science.aam7588.

Yin, Jessica; Wang, Ting-Hsin (2013): A Process-based and Simplified Carbon Footprint Model for Customized Semiconductor Products | SESH. Long Beach, CA, USA (SESHA 35th Annual Symposium), updated on 10/9/2020, checked on 10/9/2020.

Zhang, Jie-Nan; Li, Qinghao; Wang, Yi; Zheng, Jieyun; Yu, Xiqian; Li, Hong (2018): Dynamic evolution of cathode electrolyte interphase (CEI) on high voltage LiCoO₂ cathode and its interaction with Li anode. *Energy Storage Materials*, 14, 1-7. In *Energy Storage Materials* 14, pp. 1–7. DOI: 10.1016/J.ENSM.2018.02.016.

Zhang, Yayun; Su, Huijun; Ya, Miaolei; Li, Jianhua; Ho, Shih-Hsin; Zhao, Luming et al. (2019): Distribution of flame retardants in smartphones and identification of current-use organic chemicals including three novel aryl organophosphate esters. In *The Science of the total environment* 693, p. 133654. DOI: 10.1016/j.scitotenv.2019.133654.

6. ANNEX

6.1. Tested DECT phones

Following DECT phones have been tested in 2015 and 2018 by Stiftung Warentest and are still available on the German market. Numbers correspond to those used in

- Figure 54 : Standby power consumption, DECT phones / charging cradle / base station (data by Stiftung Warentest, compilation by Fraunhofer IZM), p. 64
- Figure 55 : Phone call times with fully charged batteries and charging times, DECT phones (data by Stiftung Warentest, compilation by Fraunhofer IZM), p. 64
- Figure 56 : Standby duration in standard and eco mode, DECT phones (data by Stiftung Warentest, compilation by Fraunhofer IZM), p. 65

No.	Model
(1)	Gigaset: CL660
(2)	Gigaset: SL450
(3)	Telekom: Speedphone 11 with base station
(4)	Telekom: Speedphone 51 with base station
(5)	Gigaset: CL660A
(6)	Gigaset: E560
(7)	Gigaset: SL450A Go2
(8)	Telekom: Speedphone 11 with base station and answering machine
(9)	Gigaset: E560A
(10)	Telekom: Sinus 207
(11)	Telekom: Sinus A 207
(12)	Telekom: Speedphone 51 with base station and answering machine
(13)	Panasonic: KX-TGE210
(14)	Gigaset: C430
(15)	Panasonic: KX-TGE220
(16)	Gigaset: C430A
(17)	Telekom: Sinus A 206 Comfort
(18)	Panasonic: KX-TGK320
(19)	Gigaset: E630
(20)	Panasonic: KX-TG8051
(21)	Panasonic: KX-TG8061
(22)	Telekom: Sinus 206
(23)	Gigaset: SL910
(24)	Panasonic: KX-TGH220
(25)	Telekom: Sinus 606
(26)	Telekom: Sinus A 206
(27)	Panasonic: KX-TG6811
(28)	Panasonic: KX-TG6821
(29)	Gigaset: A415
(30)	Gigaset: A415A
(31)	Panasonic: KX-TGK220
(32)	Panasonic: KX-TGQ2003
(33)	Telekom: Speedphone 114
(34)	Telekom: Speedphone 514
(35)	AVM: FRITZ!Fon C53

No.	Model
(36)	Panasonic: KX-TGQ4003
(37)	Gigaset: SL450 HX3
(38)	Gigaset: A540 CAT
(39)	AVM: Fritz!Fon C4
(40)	AVM: Fritz!Fon M2

HOW TO OBTAIN EU PUBLICATIONS

Free publications:

- one copy:
via EU Bookshop (<http://bookshop.europa.eu>);
- more than one copy or posters/maps:
from the European Union's representations (http://ec.europa.eu/represent_en.htm);
from the delegations in non-EU countries
(http://eeas.europa.eu/delegations/index_en.htm);
by contacting the Europe Direct service (http://europa.eu/europedirect/index_en.htm)
or calling 00 800 6 7 8 9 10 11 (freephone number from anywhere in the EU) (*).

(*). The information given is free, as are most calls (though some operators, phone boxes or hotels may charge you).

Priced publications:

- via EU Bookshop (<http://bookshop.europa.eu>).

Priced subscriptions:

- via one of the sales agents of the Publications Office of the European Union
(http://publications.europa.eu/others/agents/index_en.htm).

